



Polar Plots for Bose Loudspeakers

Polar plots (two dimensional) and radiation balloons (three dimensional) provide a basic understanding of the radiation pattern of loudspeakers. In the enclosed documents you will find polar plots for Bose loudspeakers.

Loudspeakers have been measured in an anechoic environment, by locating them on a turntable with a fixture that holds the speaker rigidly over the center of the turntable. The turntable is then rotated with a microphone in the far field to obtain polar measurements.

In the polar plots, 0° is the horizontal polar plot, and 90° is the vertical polar plot. All polar plots are shown on a 6dB / division scale. This data is octave-band polar data.

On each data sheet, acoustics data is shown and defined as follows:

FREQUENCY – The center frequency of the octave-band polar plot displayed

SENSITIVITY – Octave-band sound pressure level measured at 1m, when a *full-bandwidth* pink noise signal is applied to the input of the speaker (with a controller inserted when applicable) and the level adjusted to 1W at the speaker terminals

IMPEDANCE – Lists the nominal impedance of the speaker

Q – Lists the ‘Q’ factor of the speaker

MAXIMUM POWER – Lists the long-term power handling of the speaker.

For further information please consult the technical specifications of the speaker or contact your local Bose representative. You can find all polar plots on our website <http://pro.bose.com>.

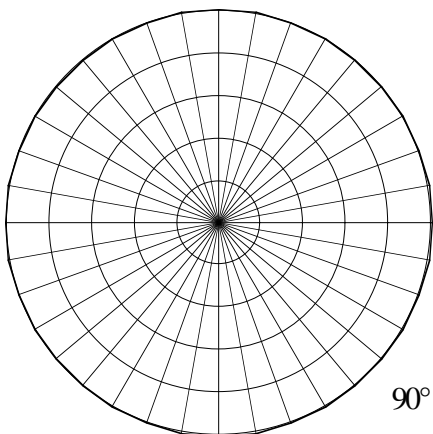
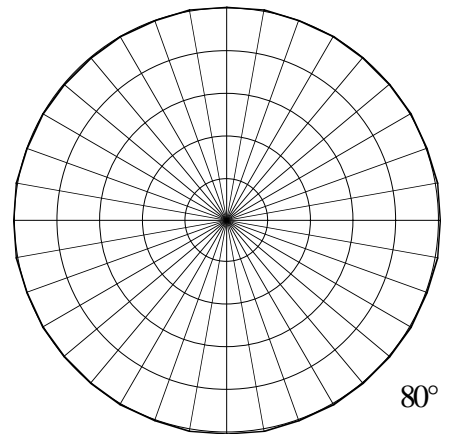
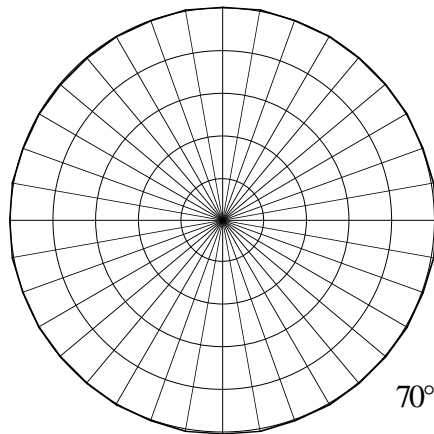
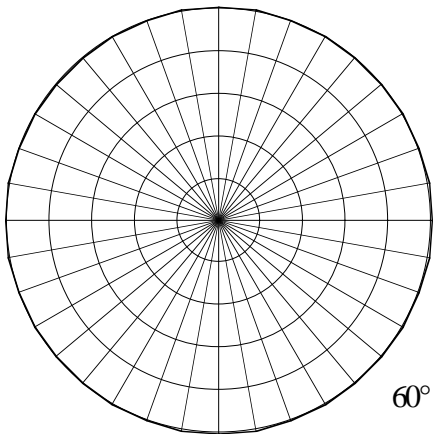
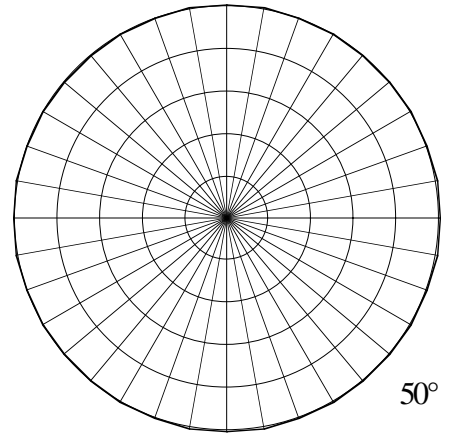
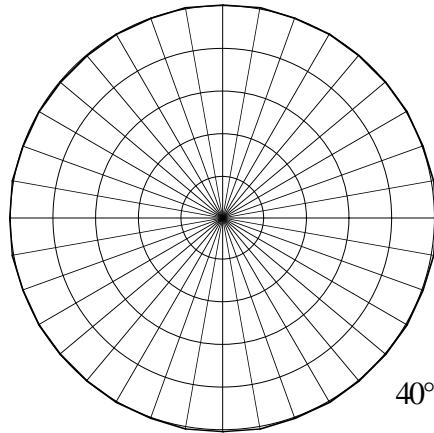
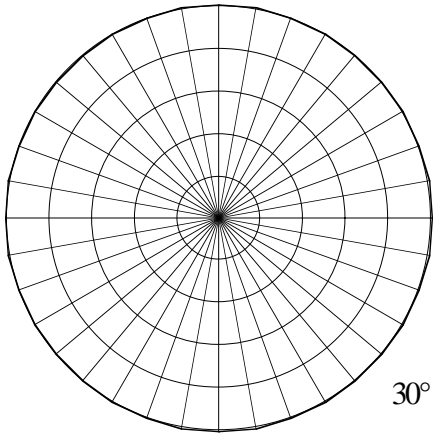
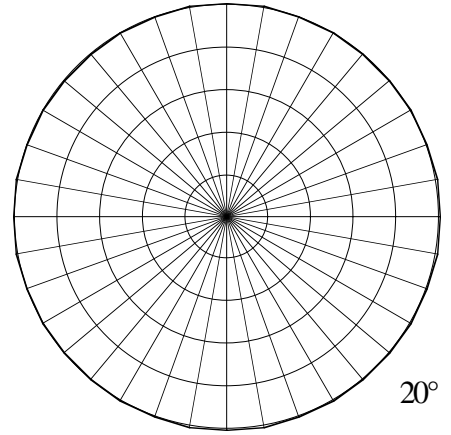
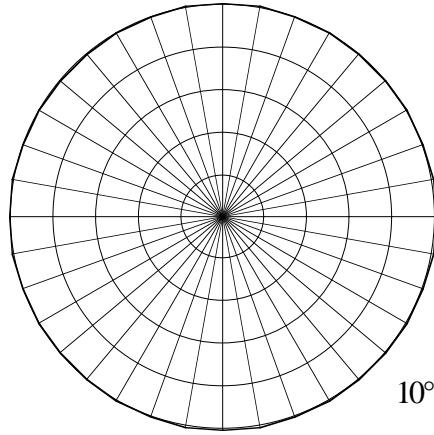
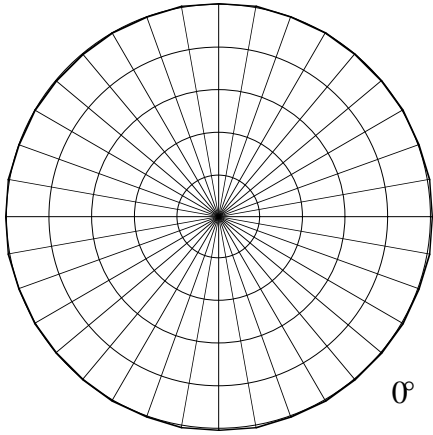

Bose Panaray® 502™A

Frequency: 125 Hz

Sensitivity: 67.2 dB @ 1W & 1m

Impedance: 8.0 Ω

Q: 1.0

Maximum Power: 150.0 Watts

6 dB/div

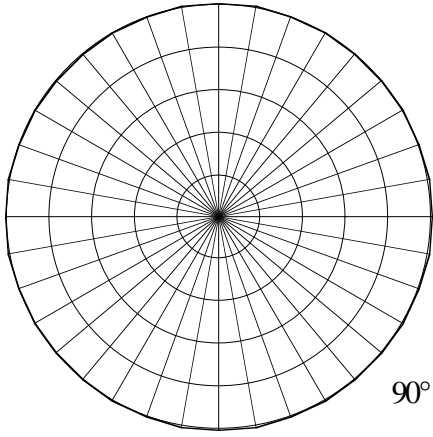

90°

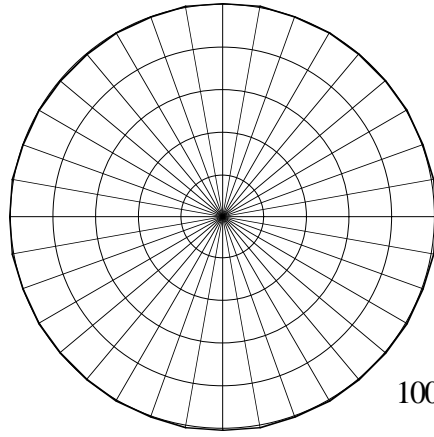

100°

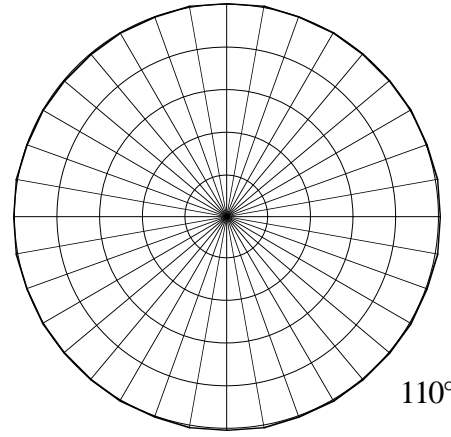

110°

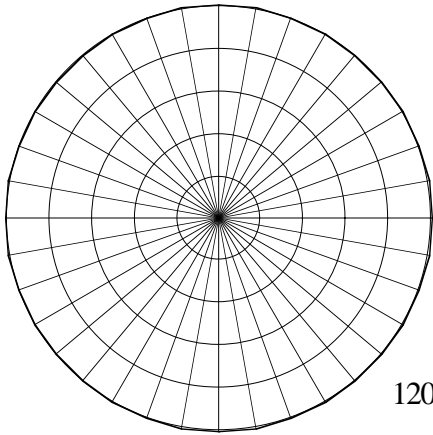

120°

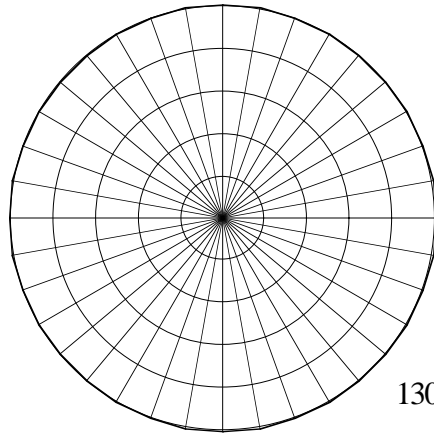

130°

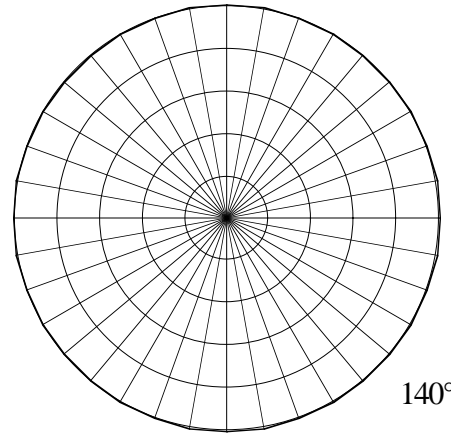

140°

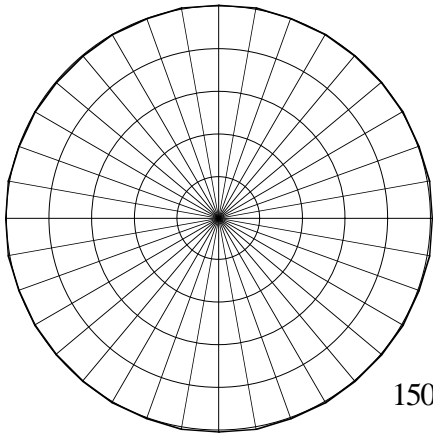

150°

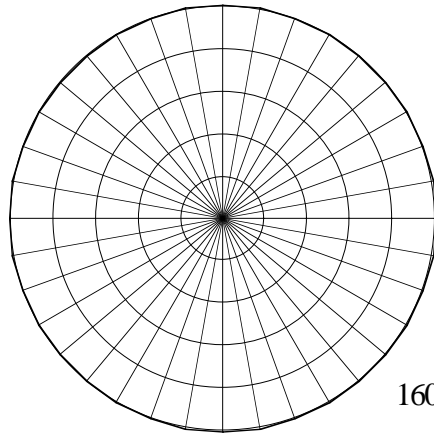

160°

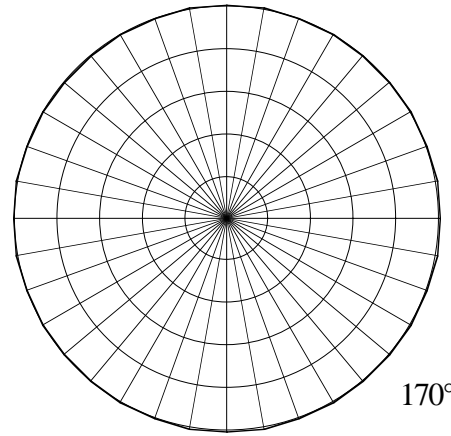

170°

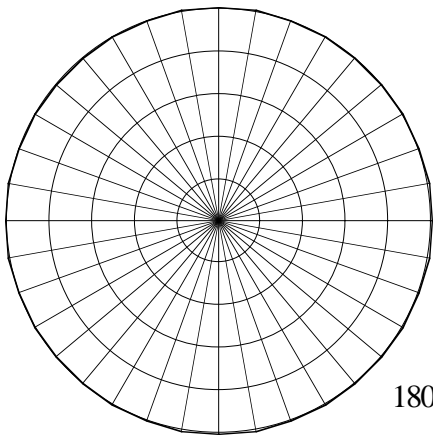

180°

Bose Panaray® 502™A

Frequency: 125 Hz

Sensitivity: 67.2 dB @ 1W & 1m

Impedance: 8.0 Ω

Q: 1.0

Maximum Power: 150.0 Watts

6 dB/div

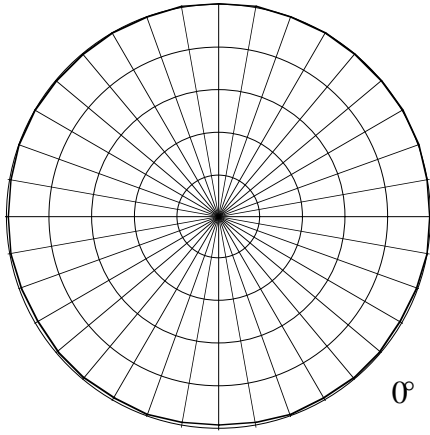

0°

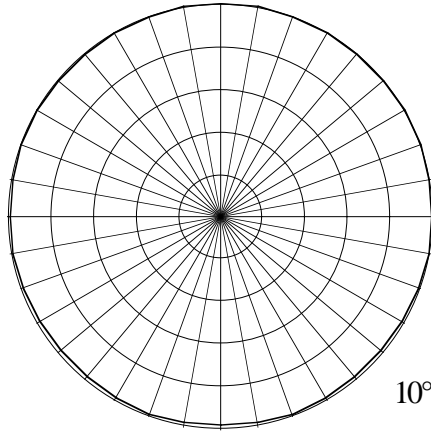

10°

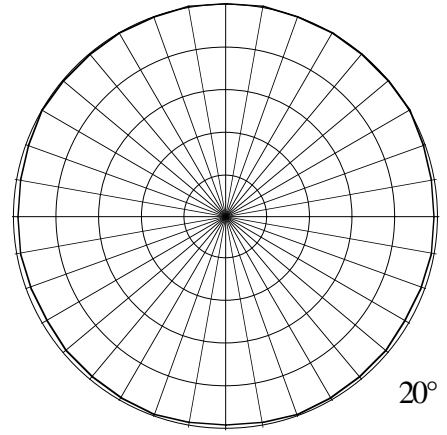

20°

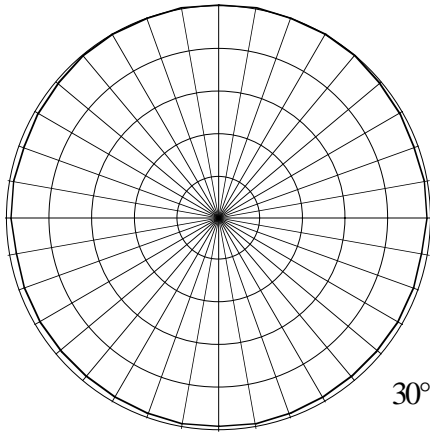

30°

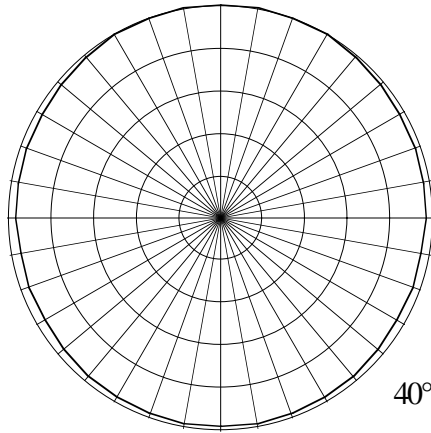

40°

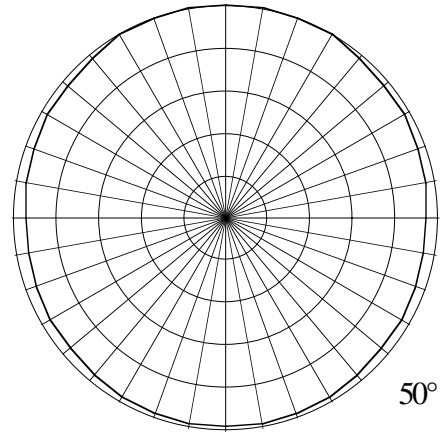

50°

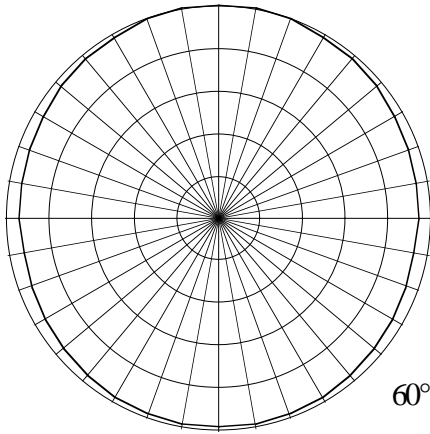

60°

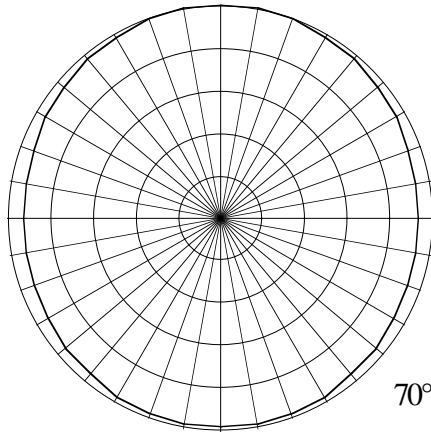

70°

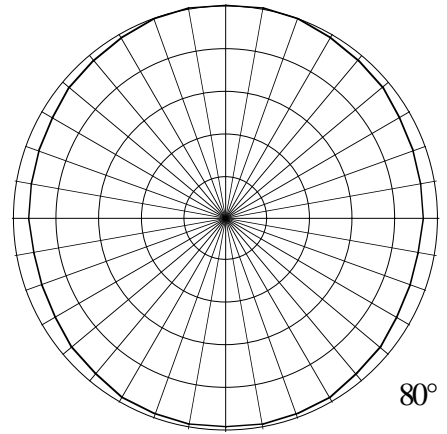

80°

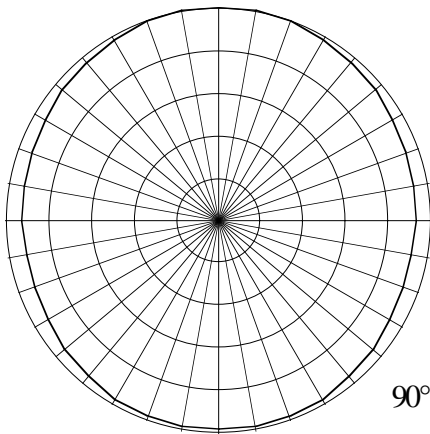

90°

Bose Panaray® 502™A

Frequency: 250 Hz

Sensitivity: 74.8 dB @ 1W & 1m

Impedance: 8.0 Ω

Q: 1.2

Maximum Power: 150.0 Watts

6 dB/div

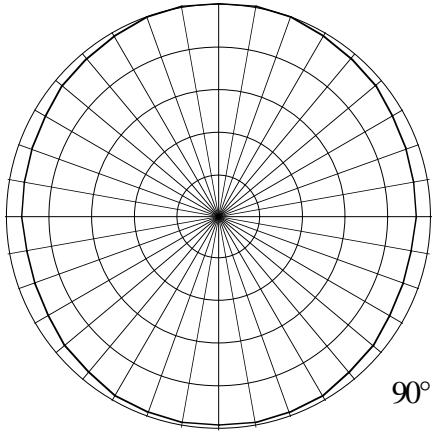

90°

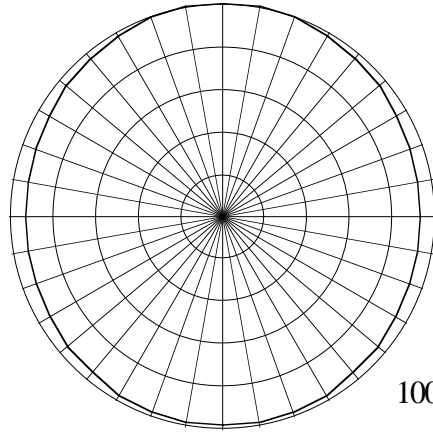

100°

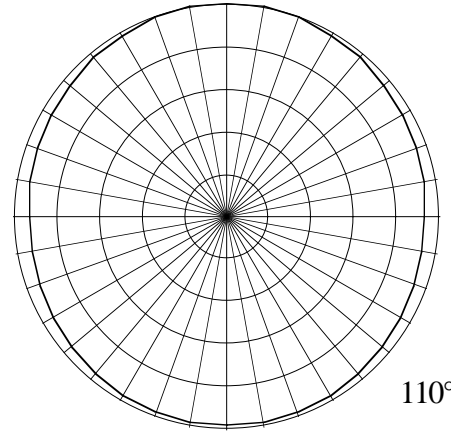

110°

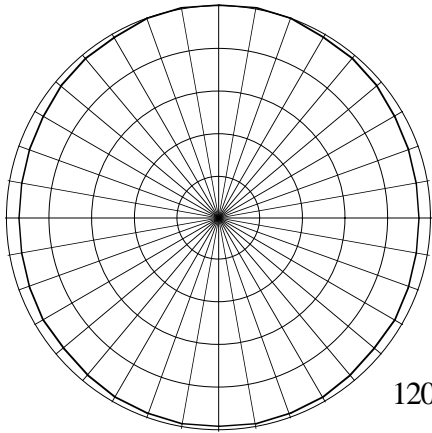

120°

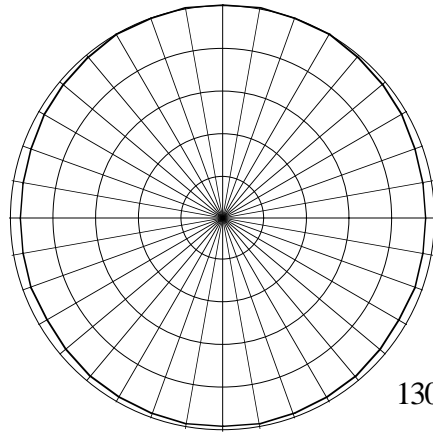

130°

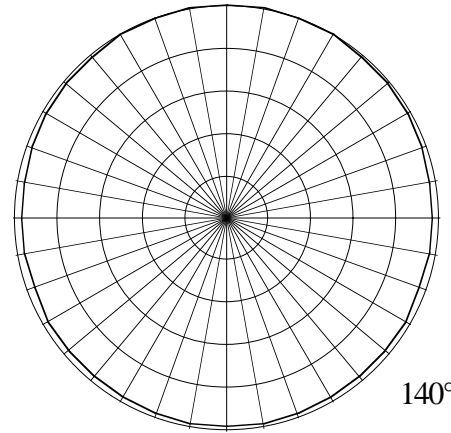

140°

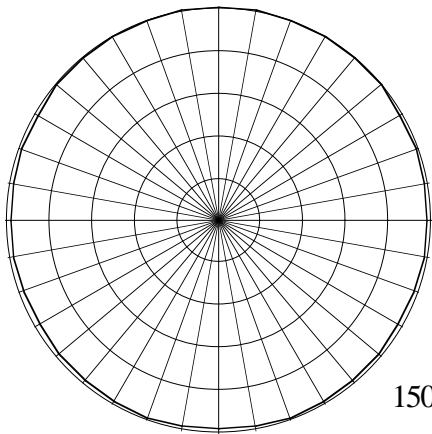

150°

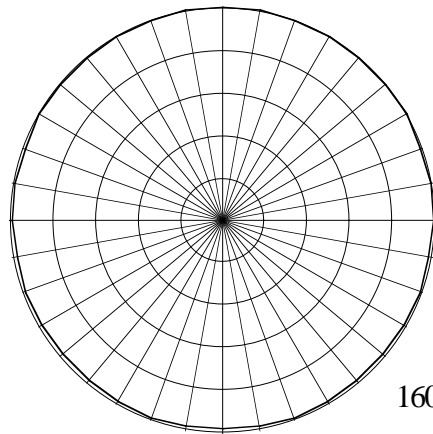

160°

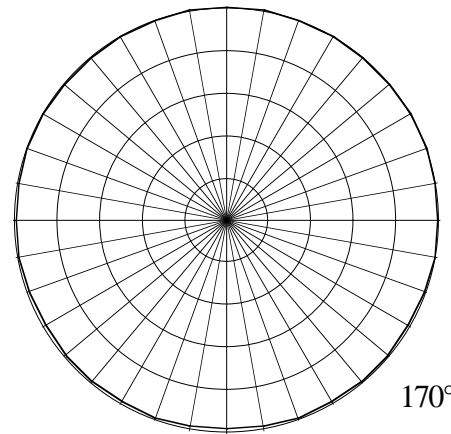

170°

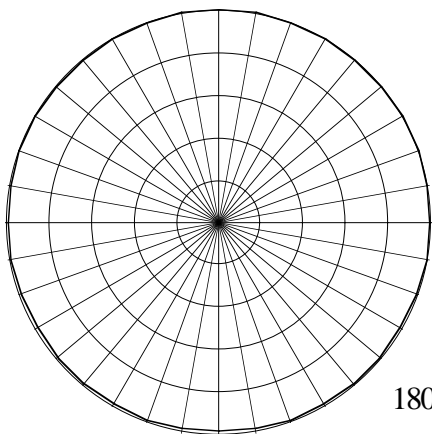

180°

Bose Panaray® 502™A

Frequency: 250 Hz

Sensitivity: 74.8 dB @ 1W & 1m

Impedance: 8.0 Ω

Q: 1.2

Maximum Power: 150.0 Watts

6 dB/div

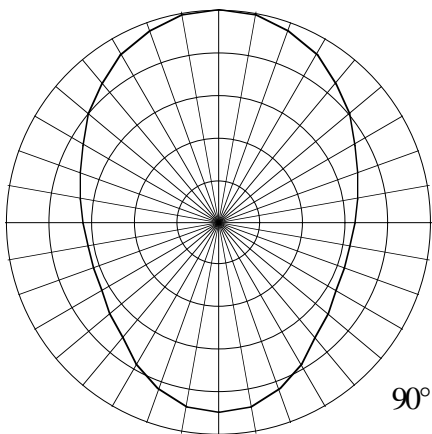
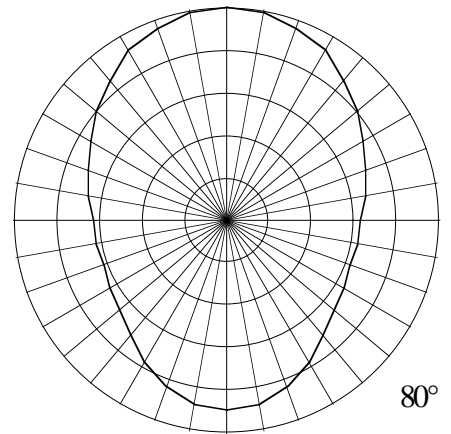
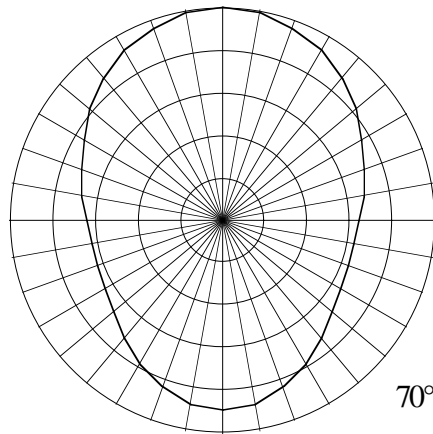
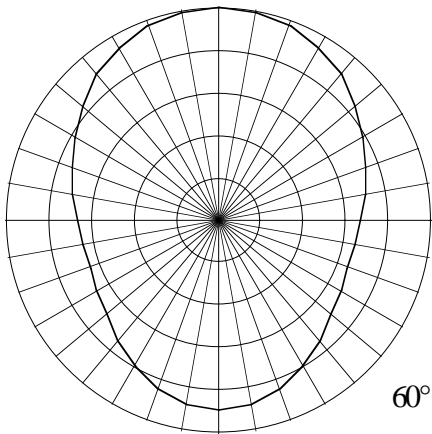
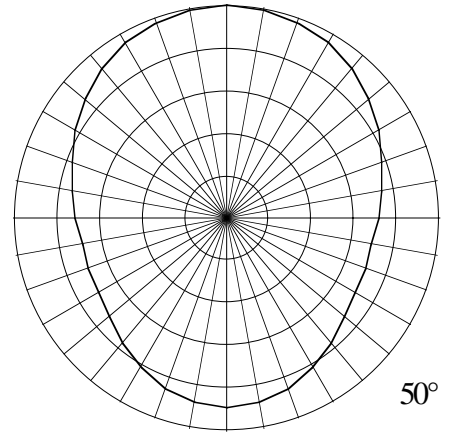
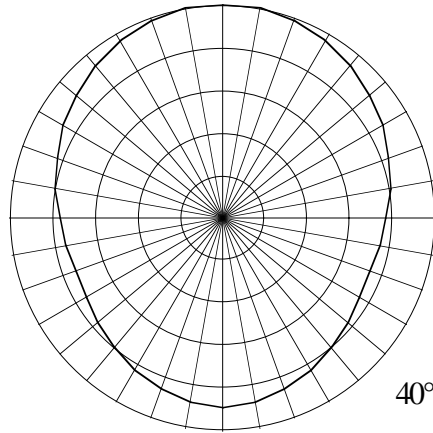
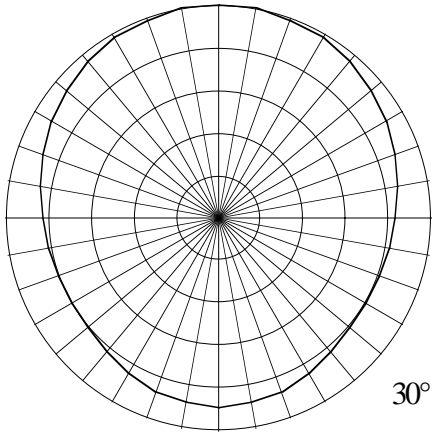
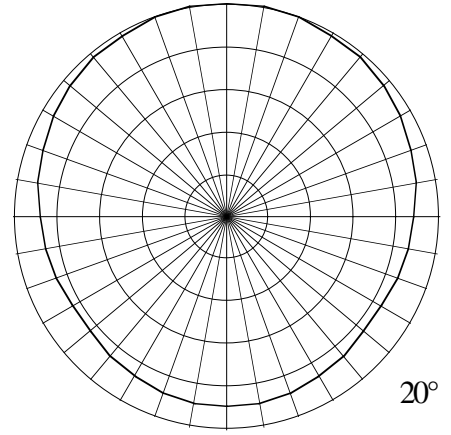
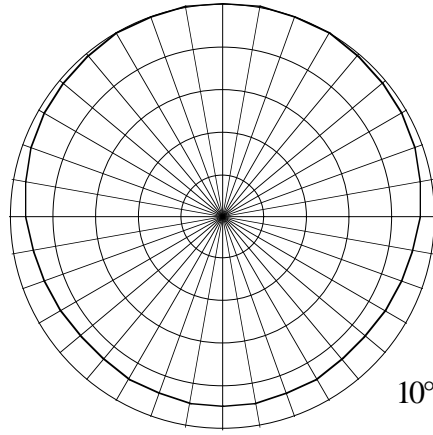
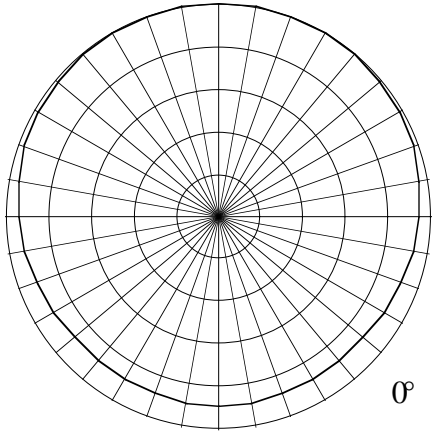

Bose Panaray® 502™A

Frequency: 500 Hz

Sensitivity: 77.2 dB @ 1W & 1m

Impedance: 8.0 Ω

Q: 2.7

Maximum Power: 150.0 Watts

6 dB/div

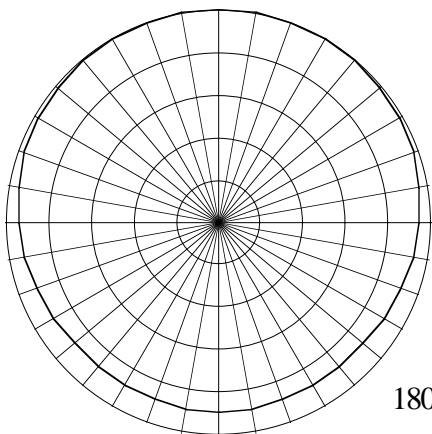
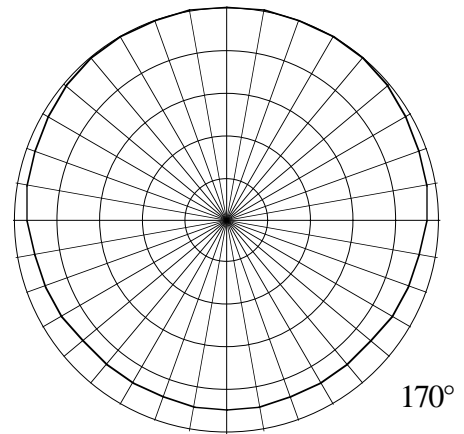
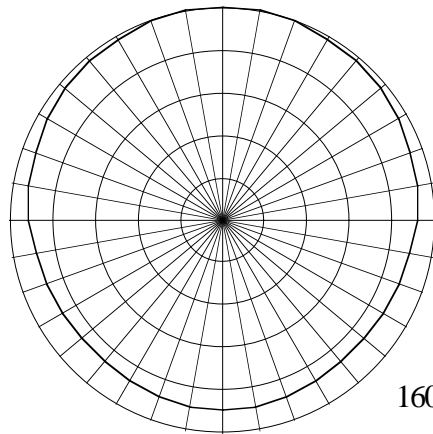
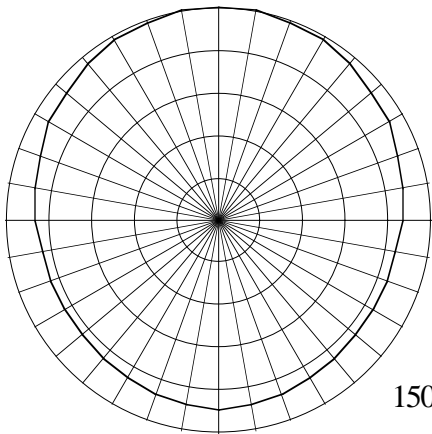
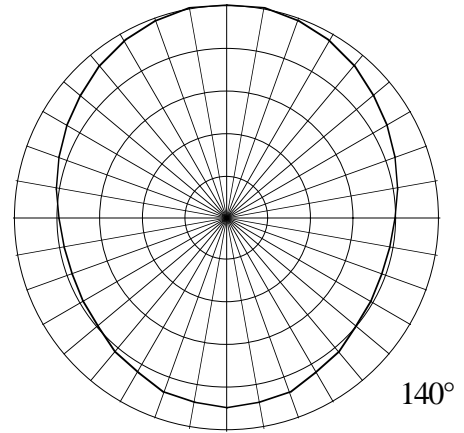
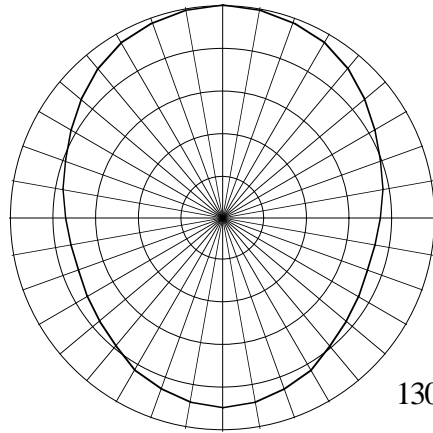
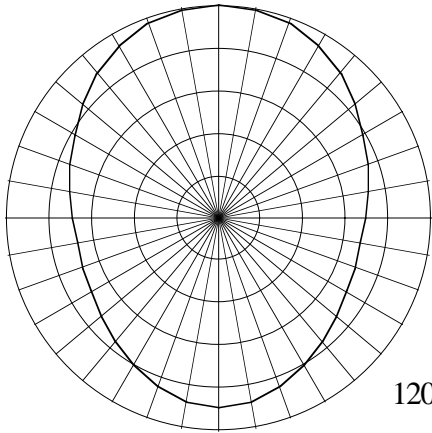
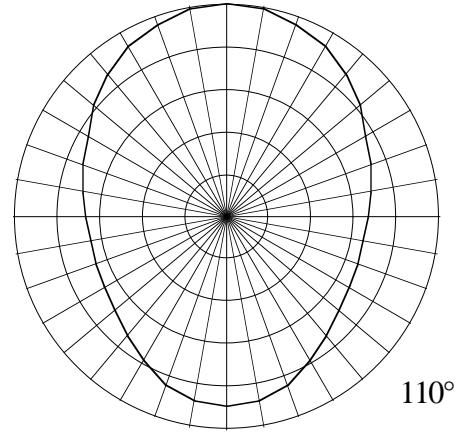
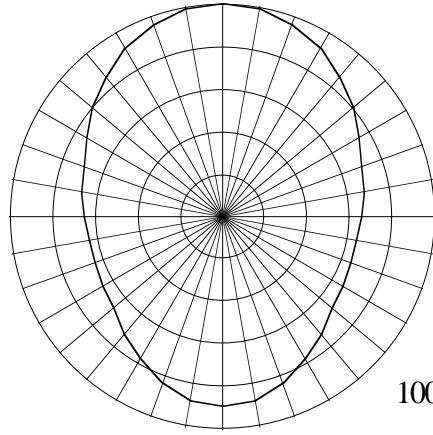
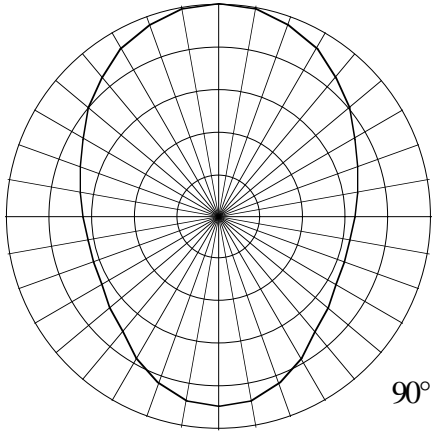

Bose Panaray® 502™A

Frequency: 500 Hz

Sensitivity: 77.2 dB @ 1W & 1m

Impedance: 8.0 Ω

Q: 2.7

Maximum Power: 150.0 Watts

6 dB/div

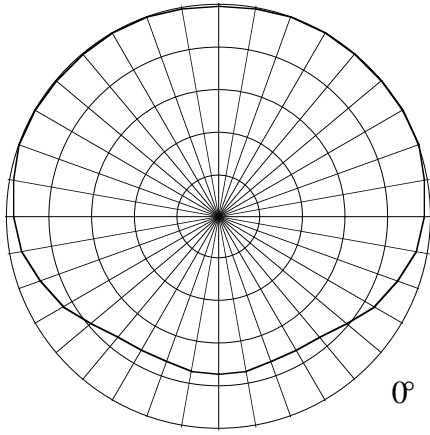

0°

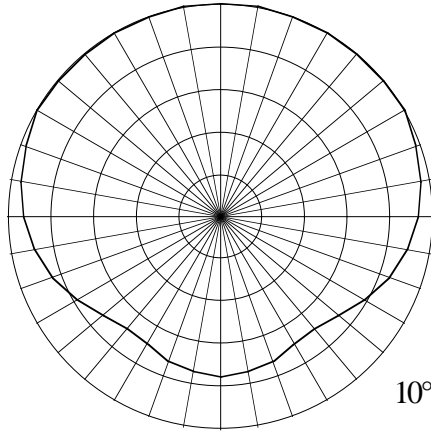

10°

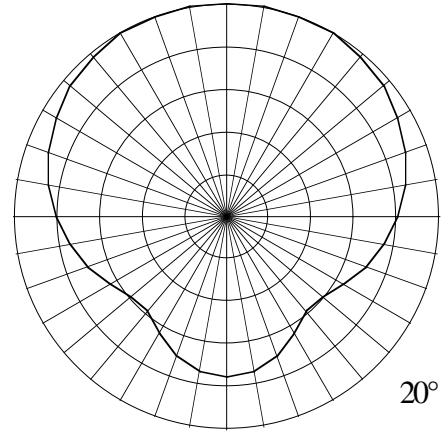

20°

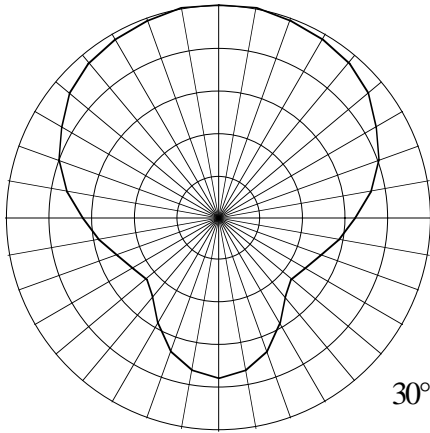

30°

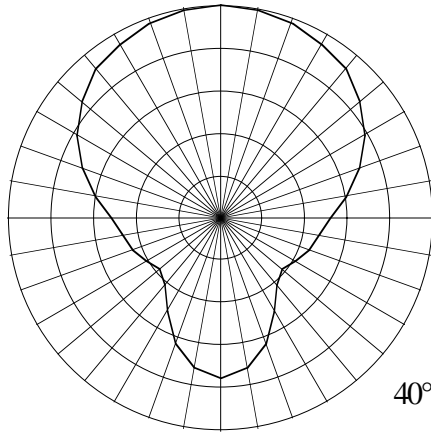

40°

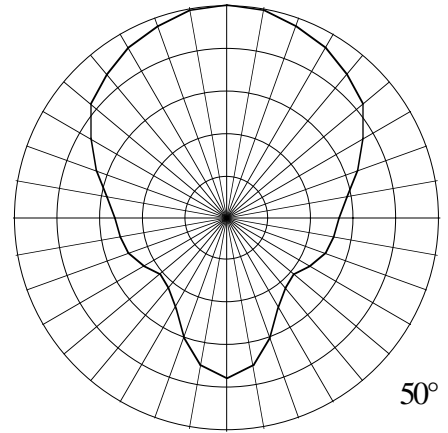

50°

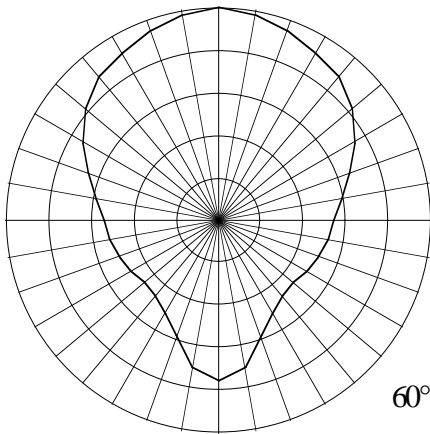

60°

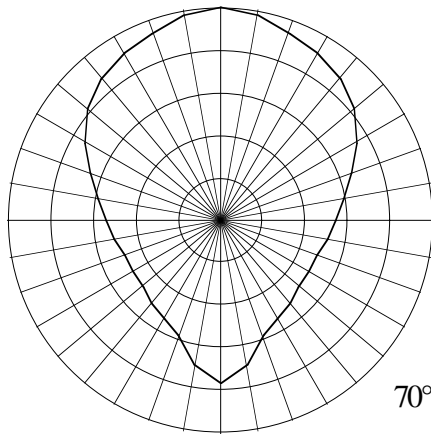

70°

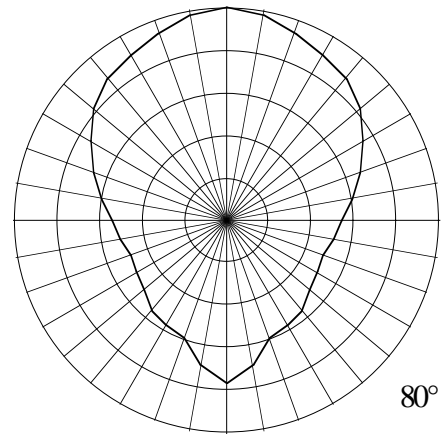

80°

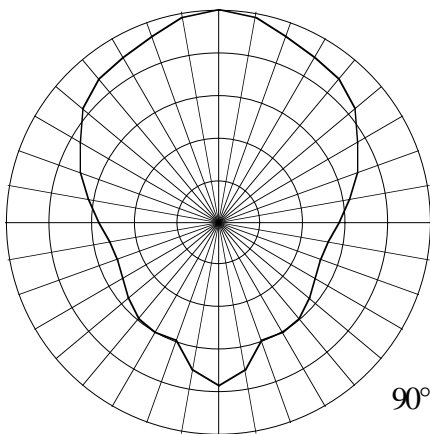

90°

Bose Panaray® 502™A

Frequency: 1000 Hz

Sensitivity: 77.1 dB @ 1W & 1m

Impedance: 8.0 Ω

Q: 3.7

Maximum Power: 150.0 Watts

6 dB/div

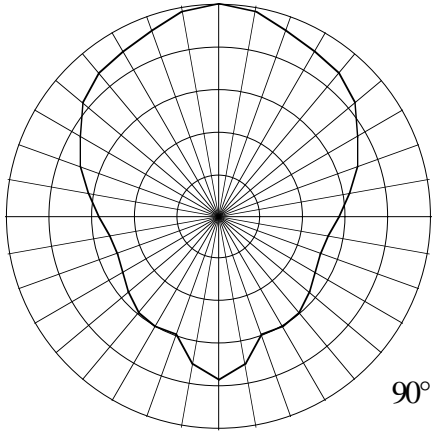

90°

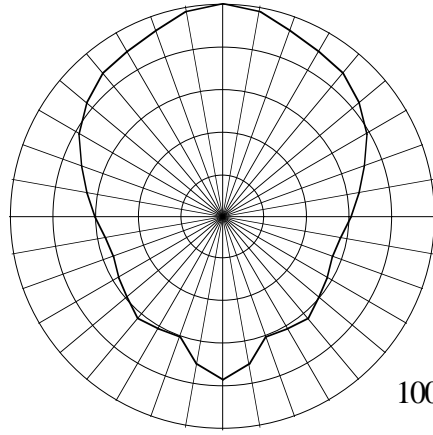

100°

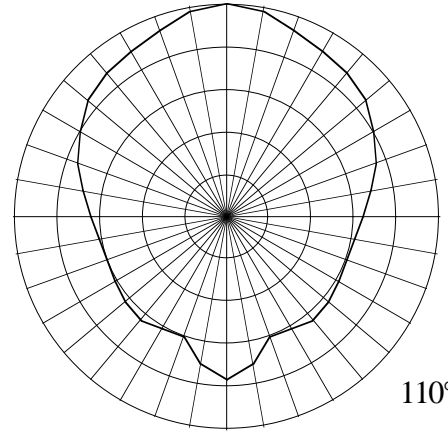

110°

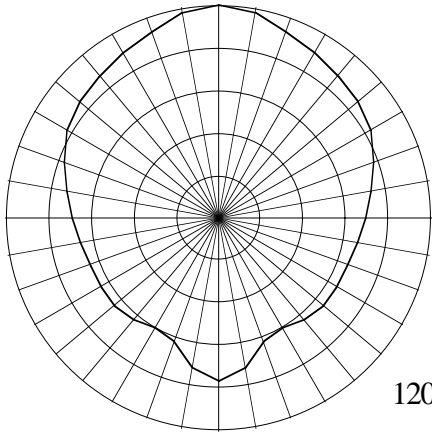

120°

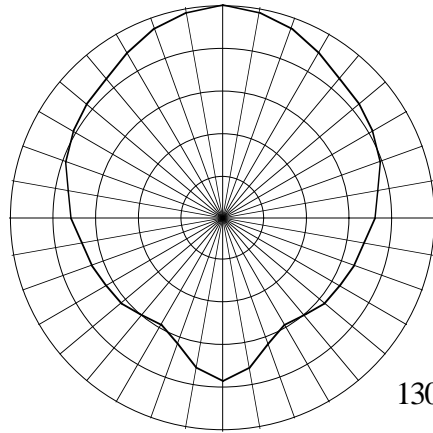

130°

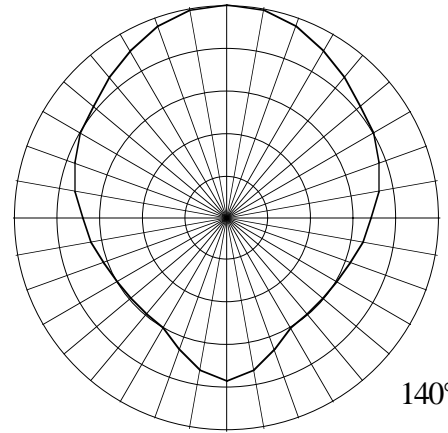

140°

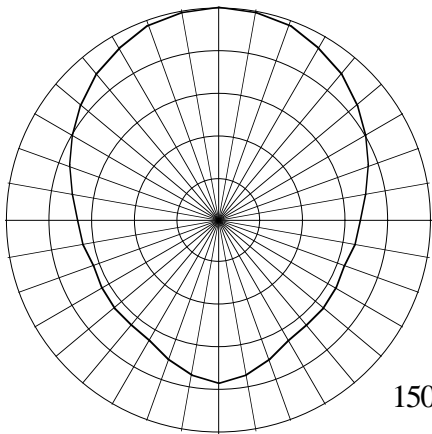

150°

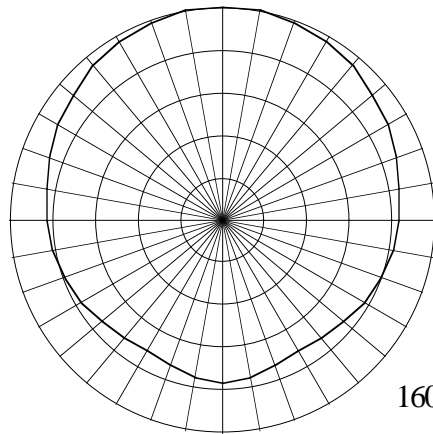

160°

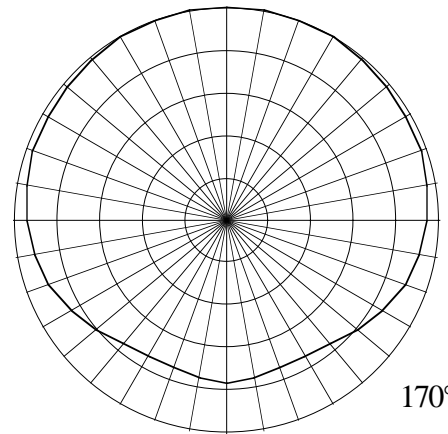

170°

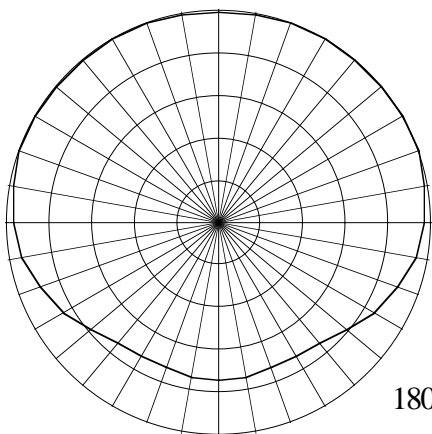

180°

Bose Panaray® 502™A

Frequency: 1000 Hz

Sensitivity: 77.1 dB @ 1W & 1m

Impedance: 8.0 Ω

Q: 3.7

Maximum Power: 150.0 Watts

6 dB/div

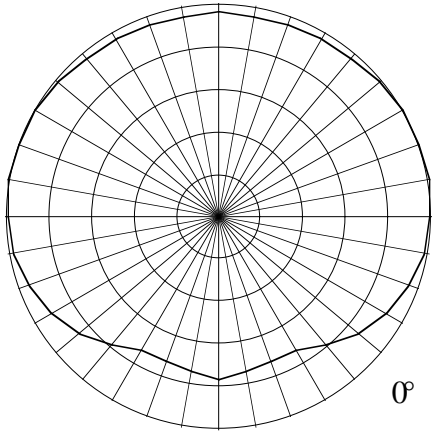

0°

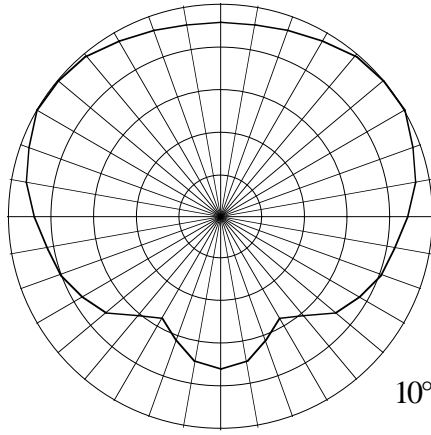

10°

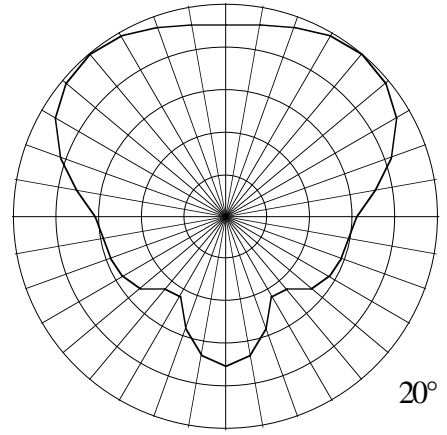

20°

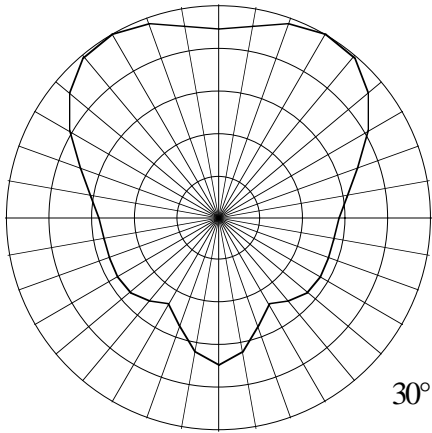

30°

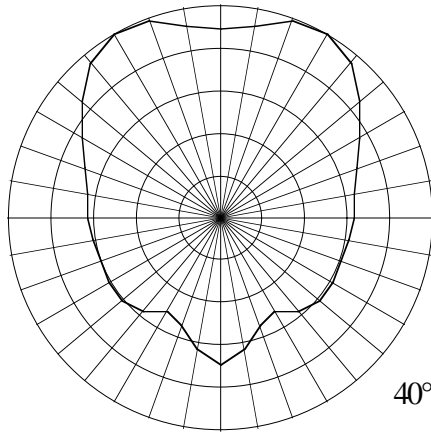

40°

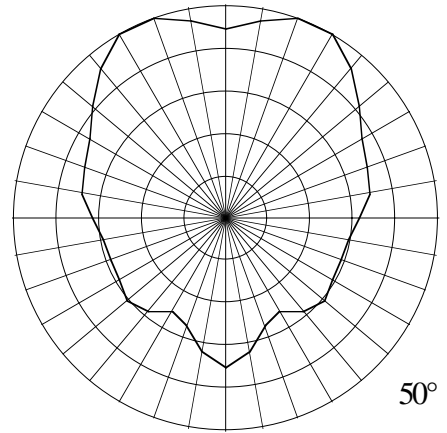

50°

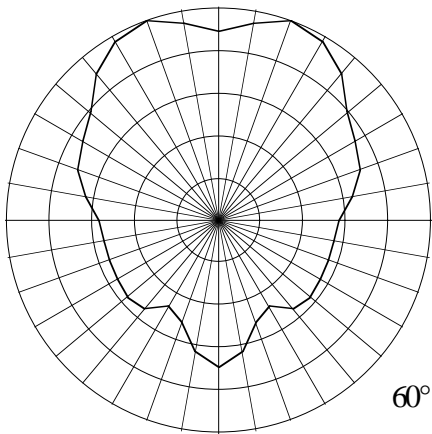

60°

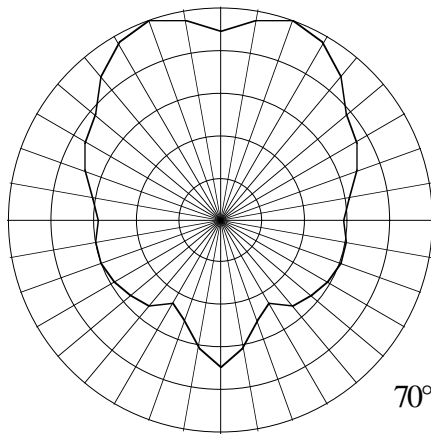

70°

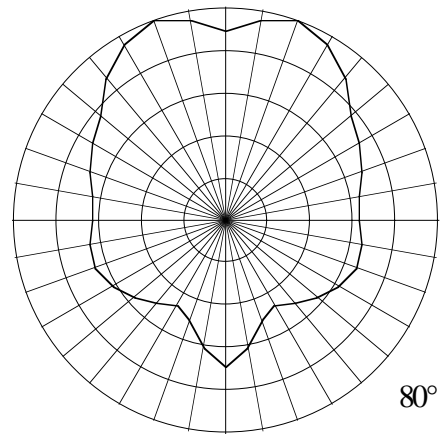

80°

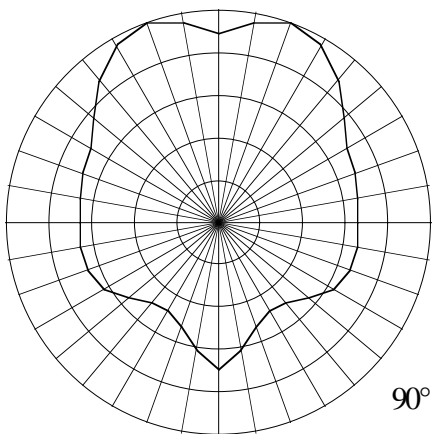

90°

Bose Panaray® 502™A

Frequency: 2000 Hz

Sensitivity: 74.2 dB @ 1W & 1m

Impedance: 8.0 Ω

Q: 2.0

Maximum Power: 150.0 Watts

6 dB/div

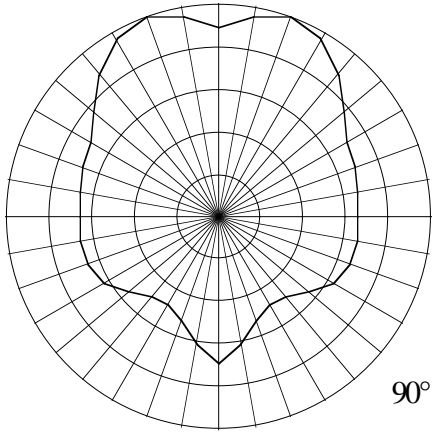

90°

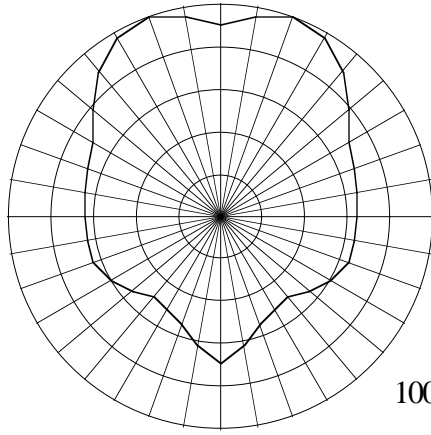

100°

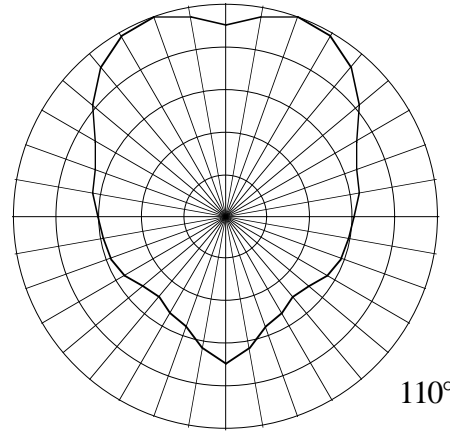

110°

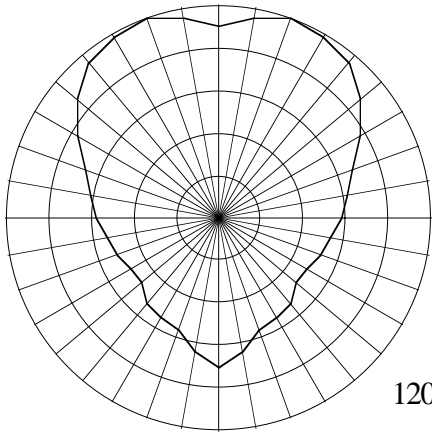

120°

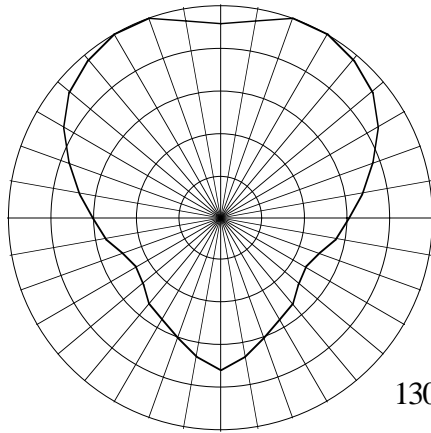

130°

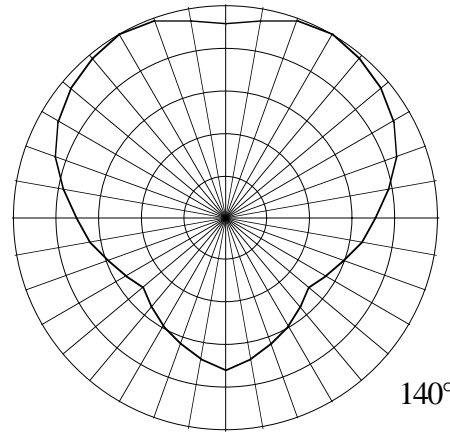

140°

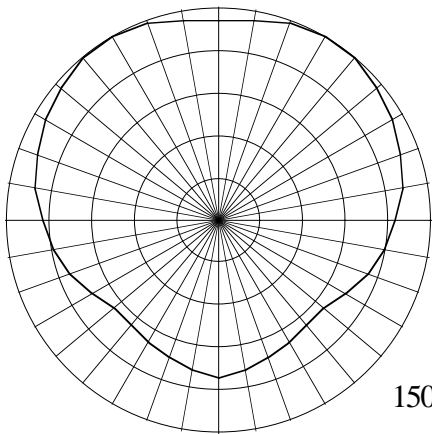

150°

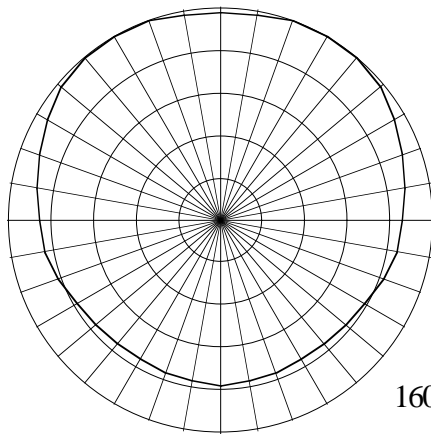

160°

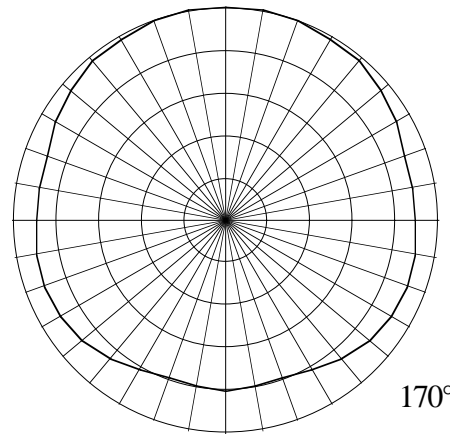

170°

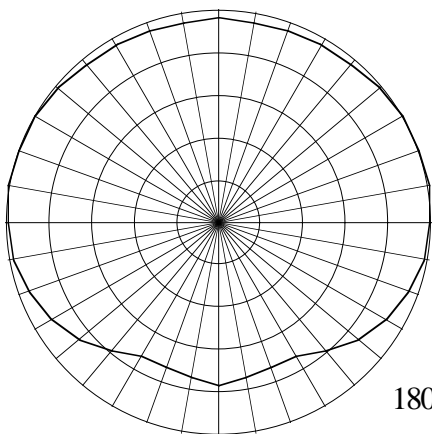

180°

Bose Panaray® 502™A

Frequency: 2000 Hz

Sensitivity: 74.2 dB @ 1W & 1m

Impedance: 8.0 Ω

Q: 2.0

Maximum Power: 150.0 Watts

6 dB/div

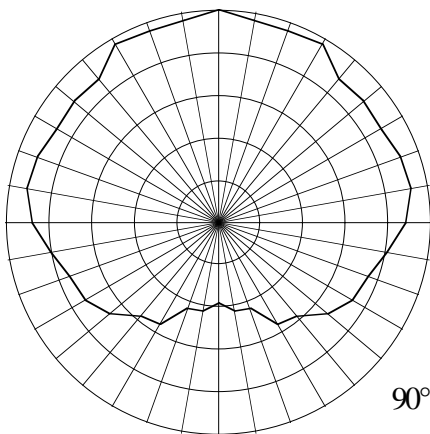
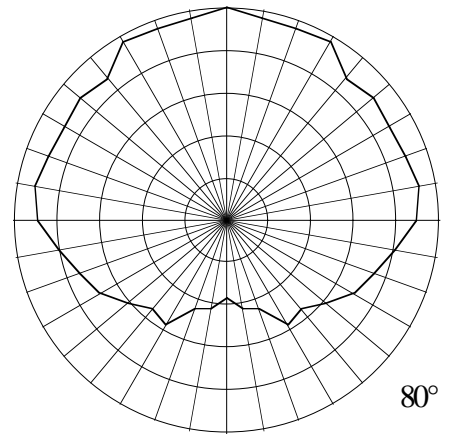
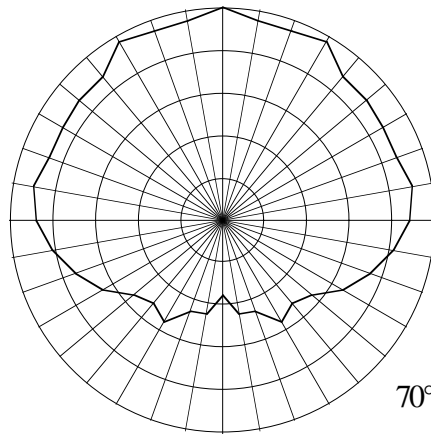
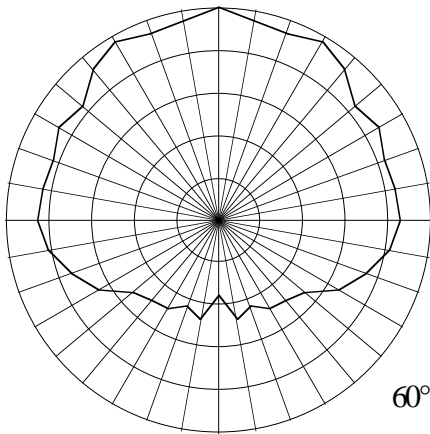
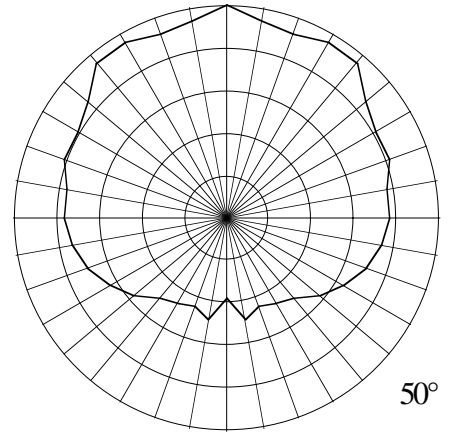
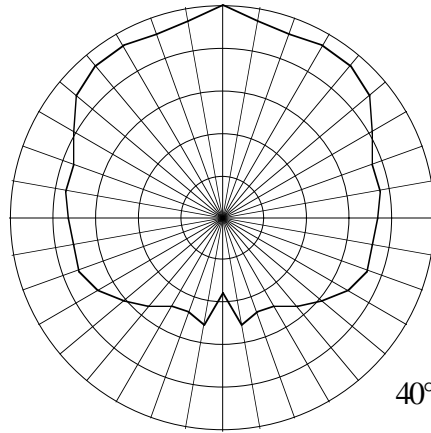
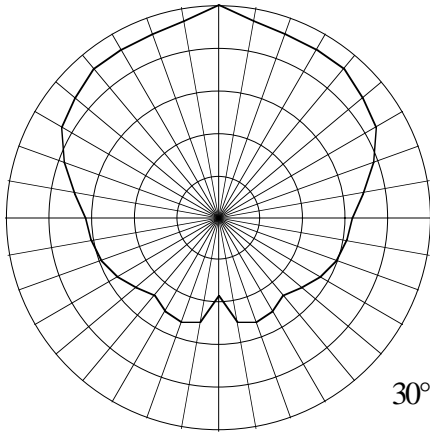
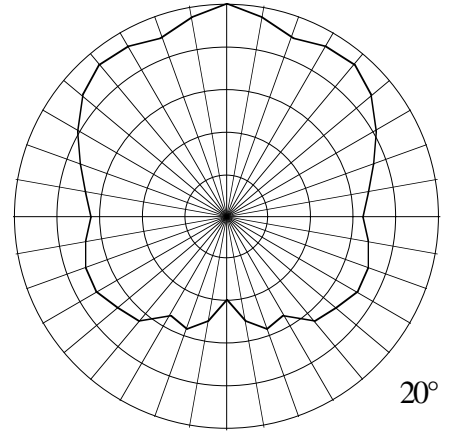
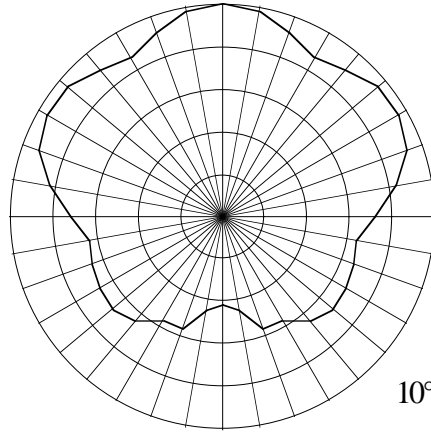
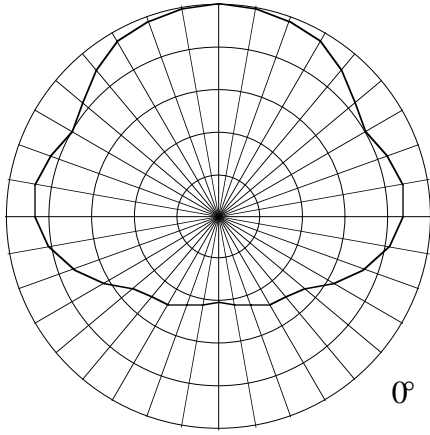

Bose Panaray® 502™A

Frequency: 4000 Hz

Sensitivity: 75.5 dB @ 1W & 1m

Impedance: 8.0 Ω

Q: 3.6

Maximum Power: 150.0 Watts

6 dB/div

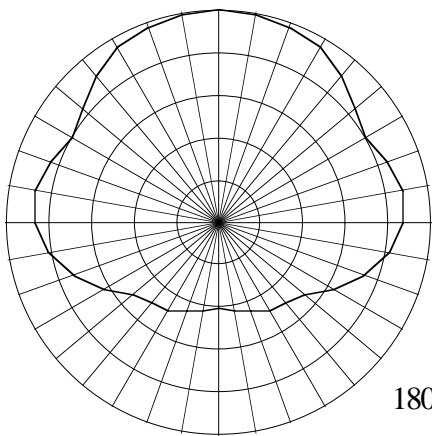
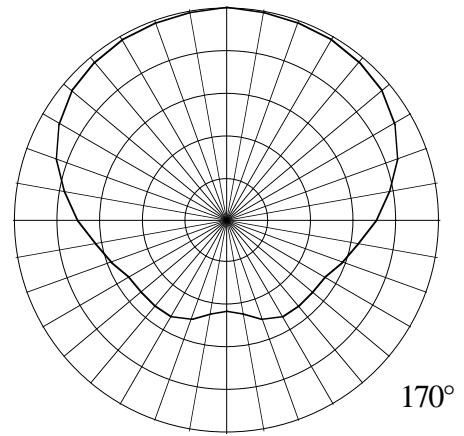
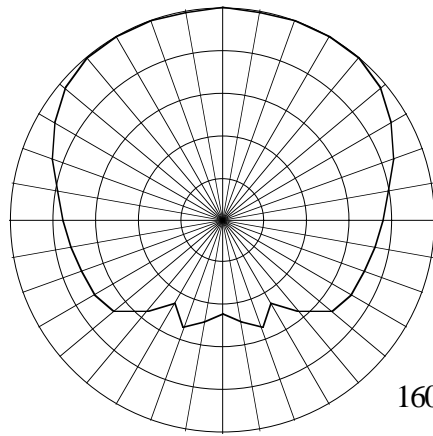
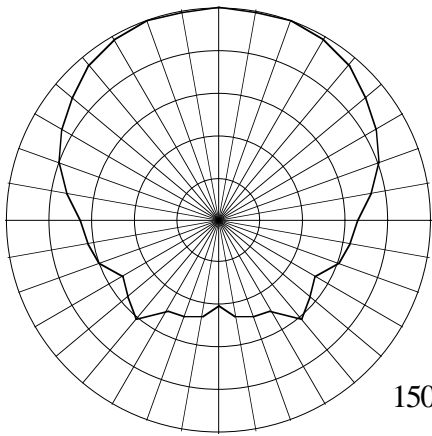
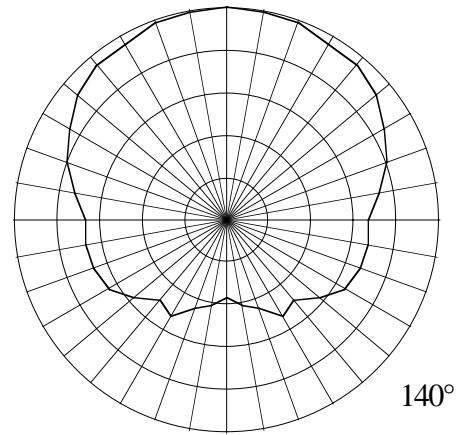
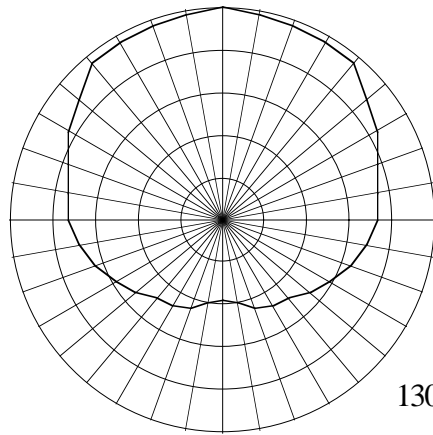
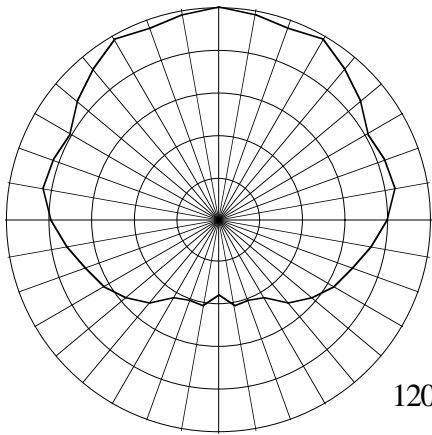
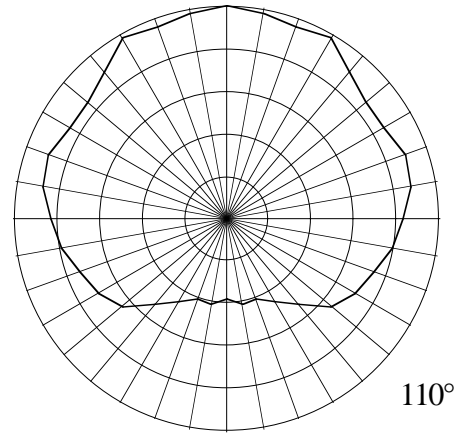
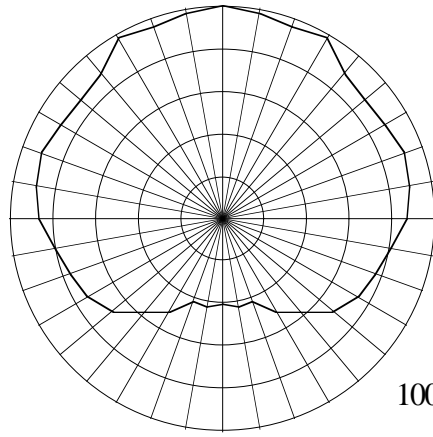
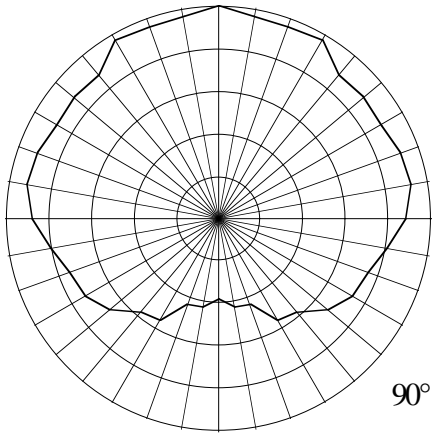

Bose Panaray® 502™A

Frequency: 4000 Hz

Sensitivity: 75.5 dB @ 1W & 1m

Impedance: 8.0 Ω

Q: 3.6

Maximum Power: 150.0 Watts

6 dB/div

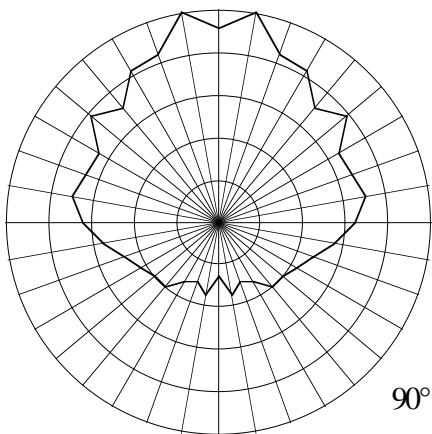
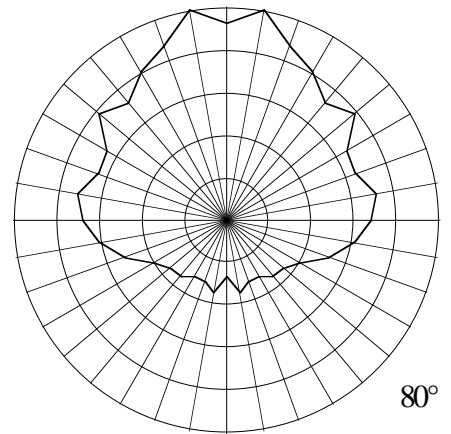
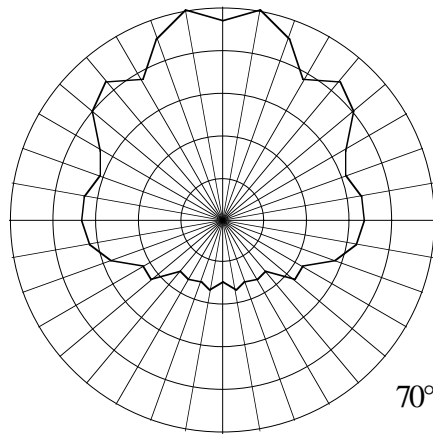
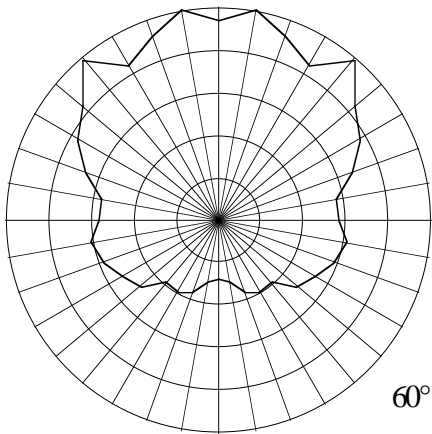
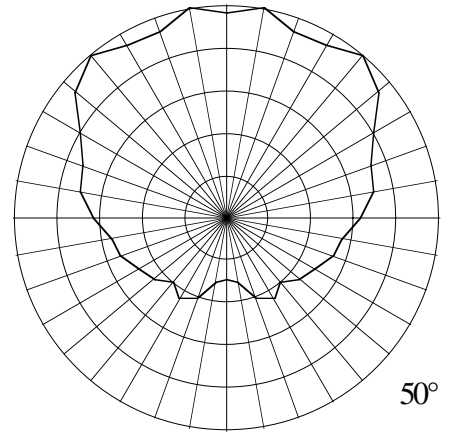
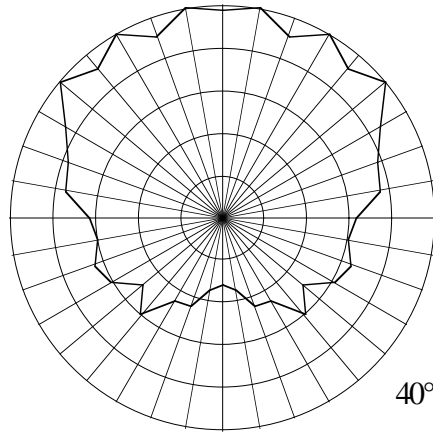
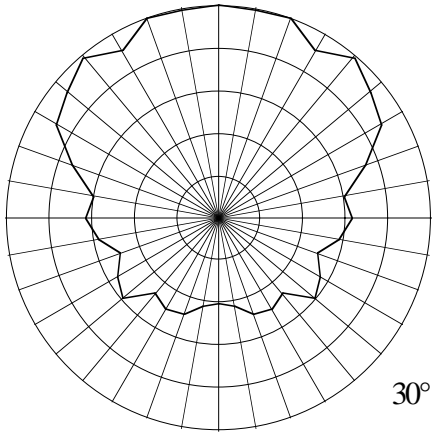
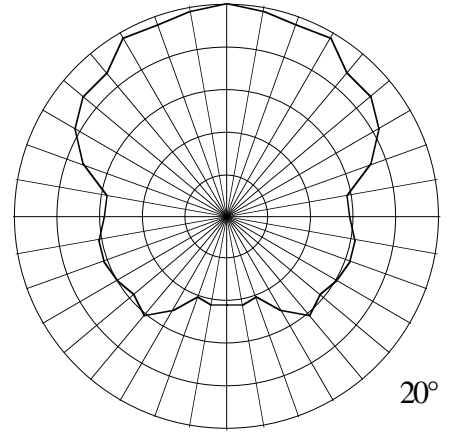
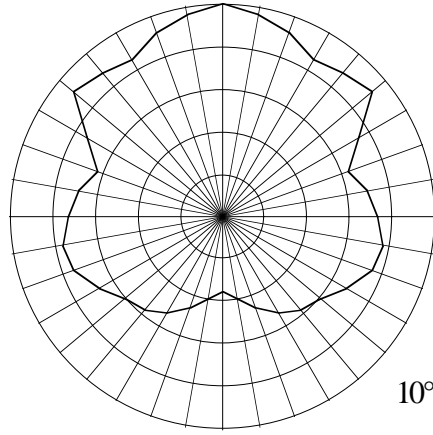
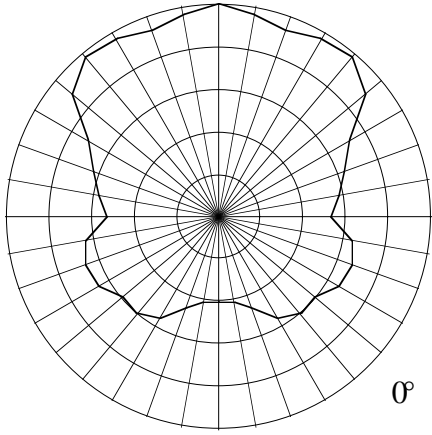

Bose Panaray® 502™A

Frequency: 8000 Hz

Sensitivity: 75.0 dB @ 1W & 1m

Impedance: 8.0 Ω

Q: 4.0

Maximum Power: 150.0 Watts

6 dB/div

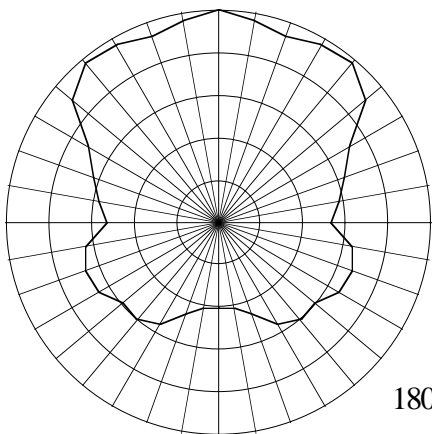
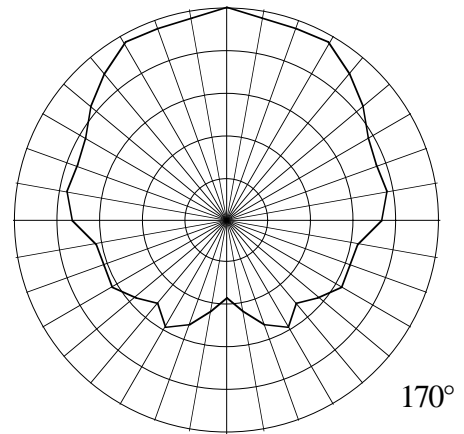
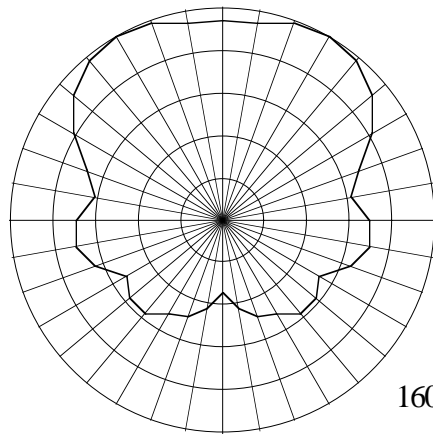
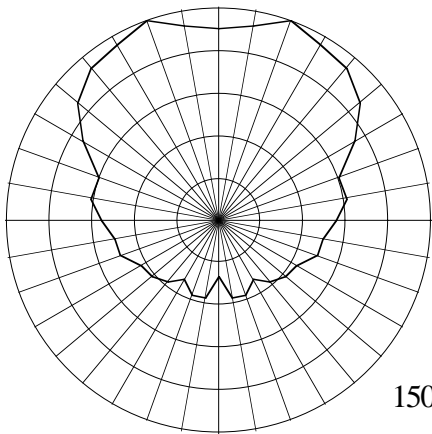
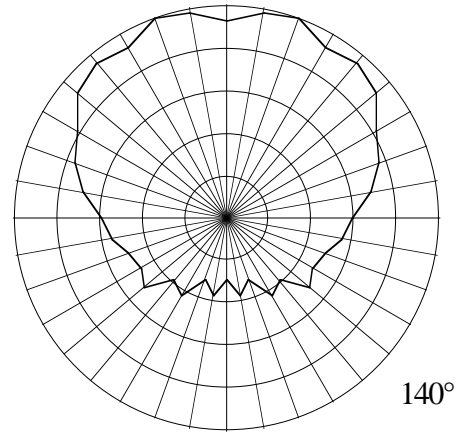
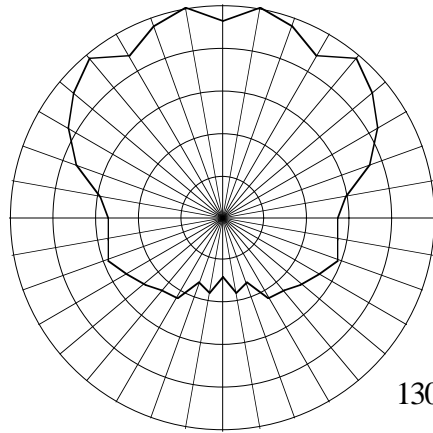
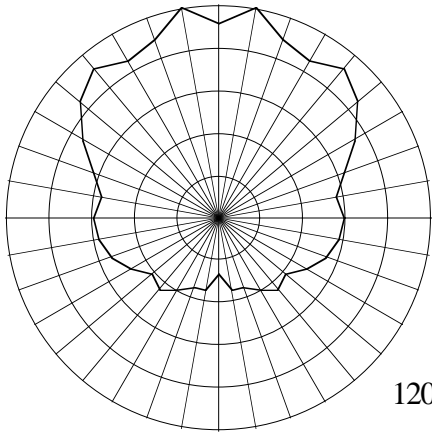
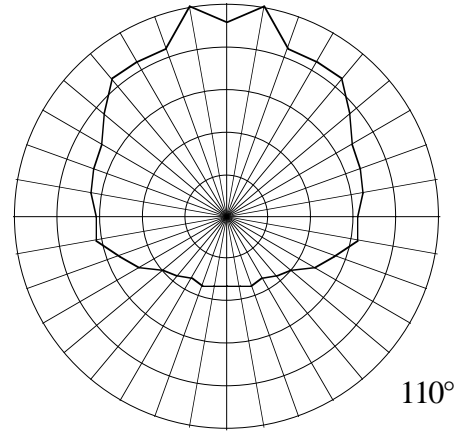
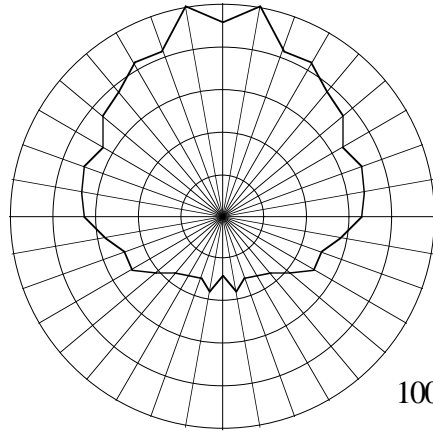
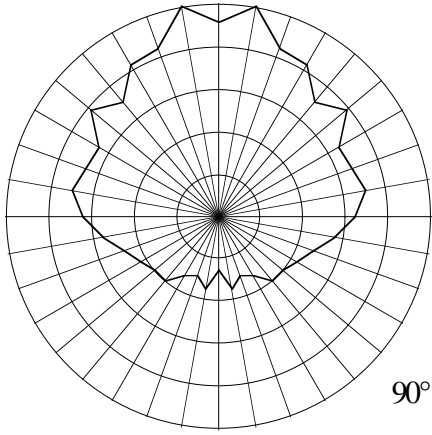

Bose Panaray® 502™A

Frequency: 8000 Hz

Sensitivity: 75.0 dB @ 1W & 1m

Impedance: 8.0 Ω

Q: 4.0

Maximum Power: 150.0 Watts

6 dB/div

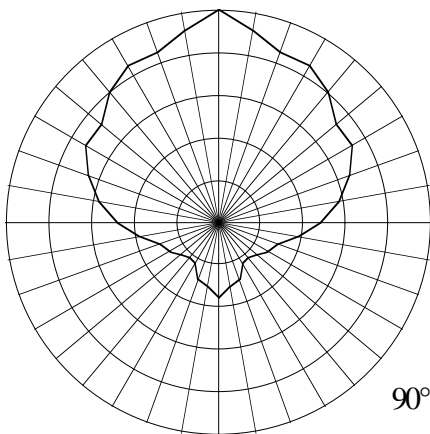
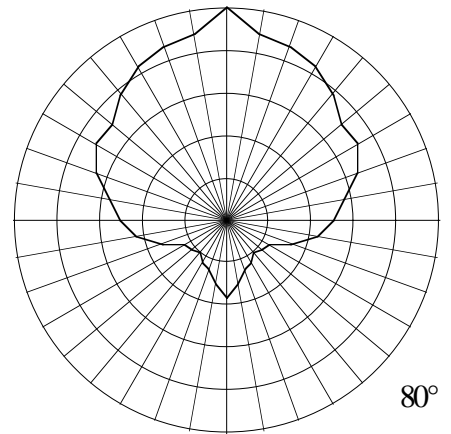
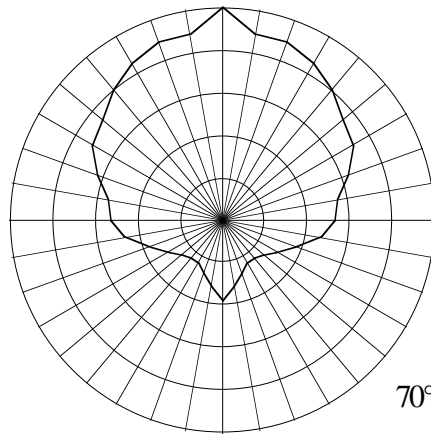
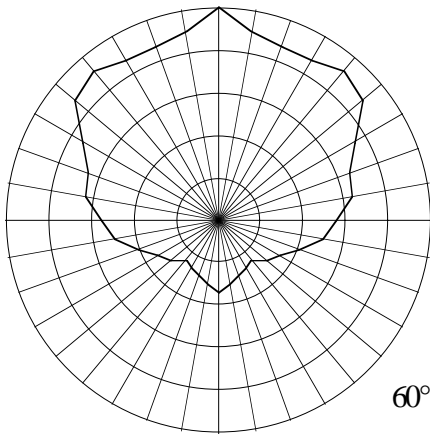
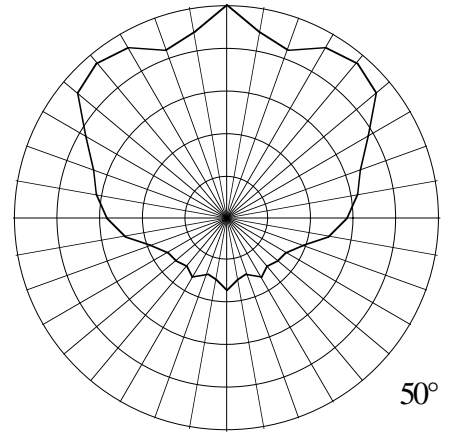
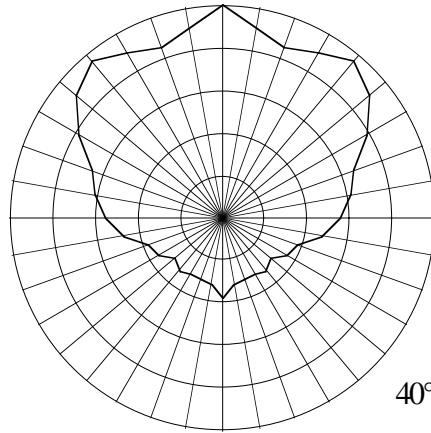
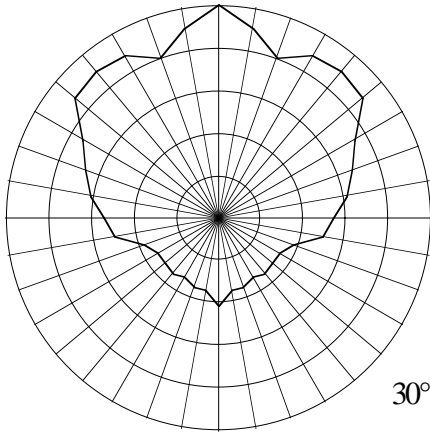
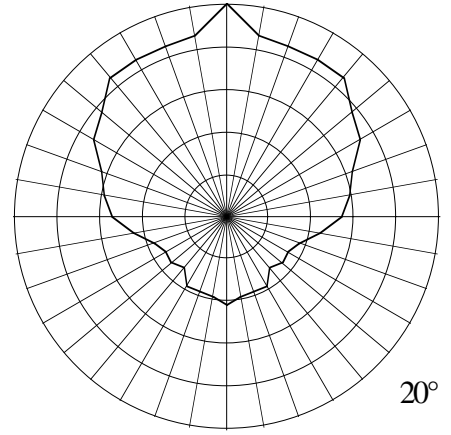
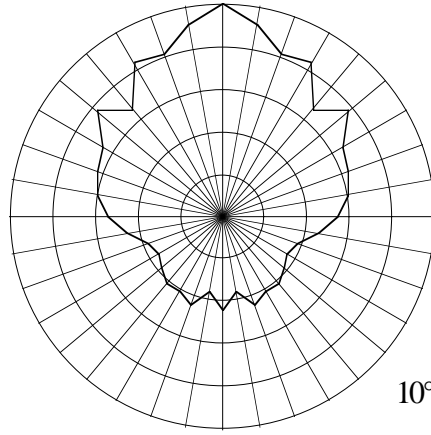
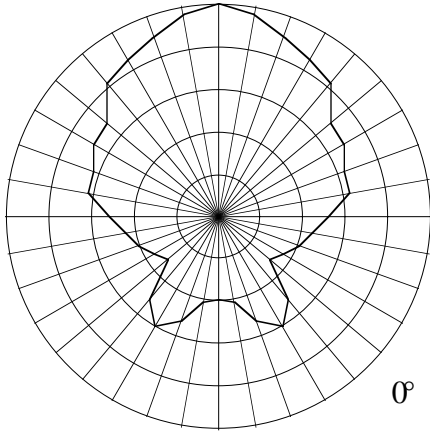

Bose Panaray® 502™A

Frequency: 16000 Hz

Sensitivity: 75.9 dB @ 1W & 1m

Impedance: 8.0 Ω

Q: 7.8

Maximum Power: 150.0 Watts

6 dB/div

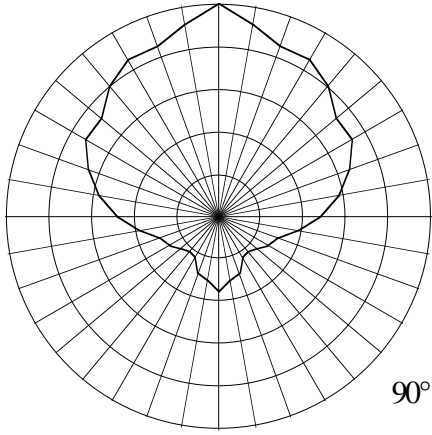

90°

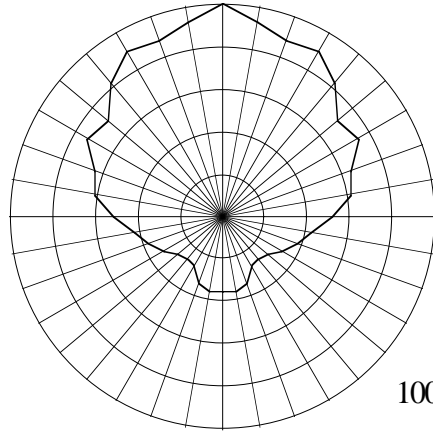

100°

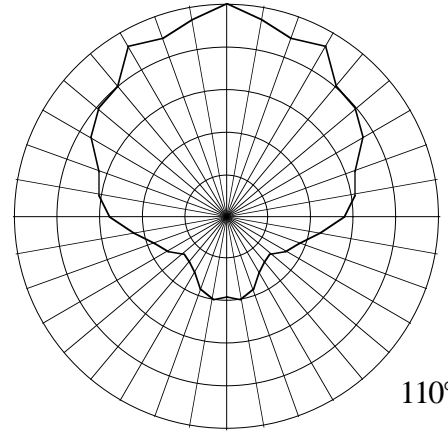

110°

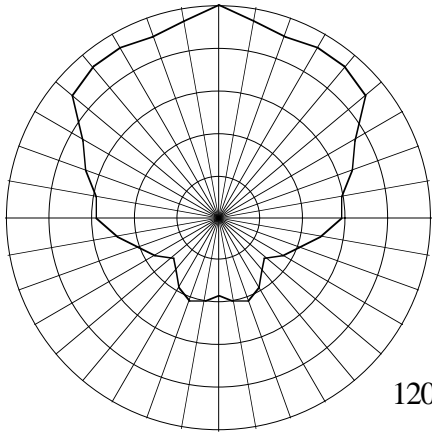

120°

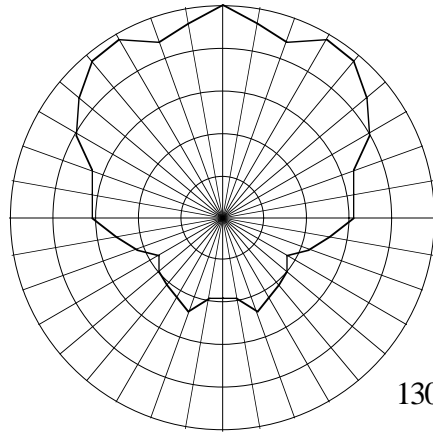

130°

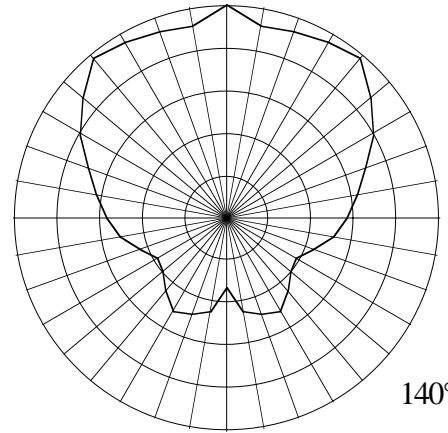

140°

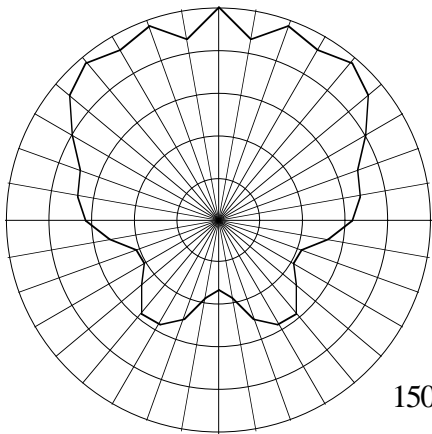

150°

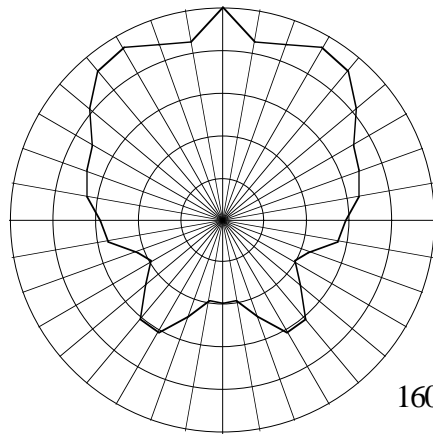

160°

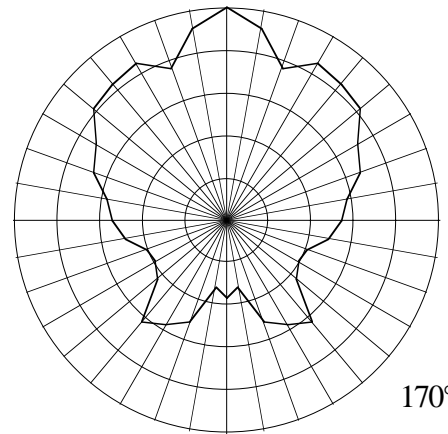

170°

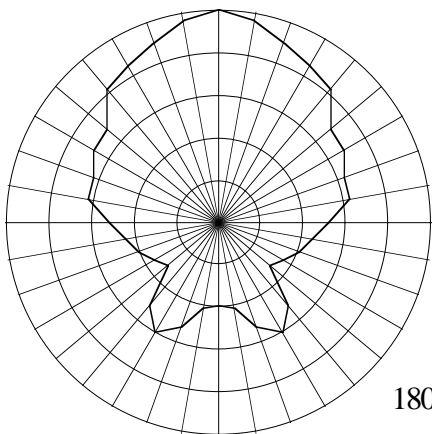

180°

Bose Panaray® 502™A

Frequency: 16000 Hz

Sensitivity: 75.9 dB @ 1W & 1m

Impedance: 8.0 Ω

Q: 7.8

Maximum Power: 150.0 Watts

6 dB/div