

横置き  
Individual

単位:mm

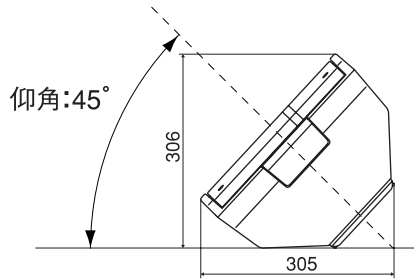

60°H ↓ 45°  
120°V

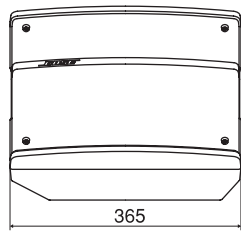
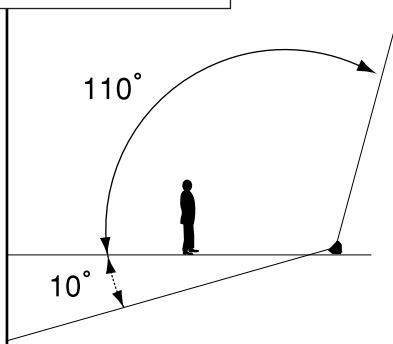

垂直: 110°

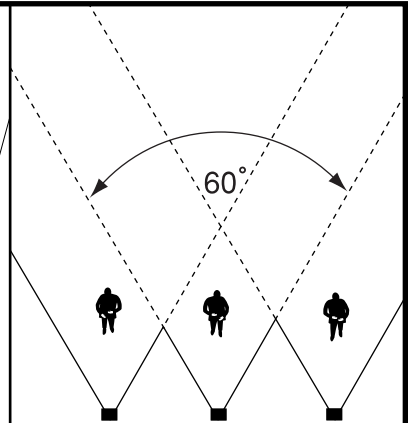

水平: 60°

縦置き1  
Group-Far

単位:mm

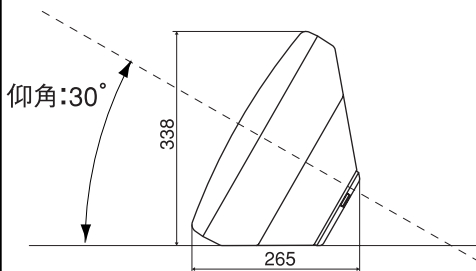
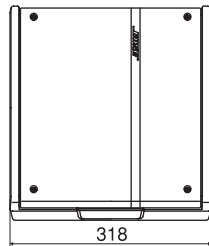

120°H ↓ 60°  
60°V

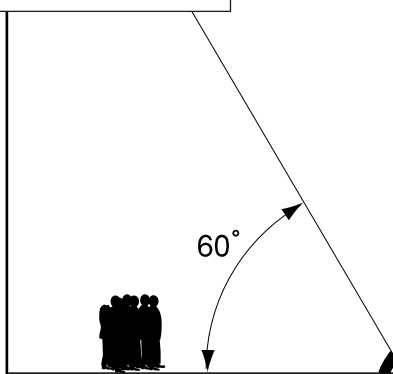

垂直: 60°

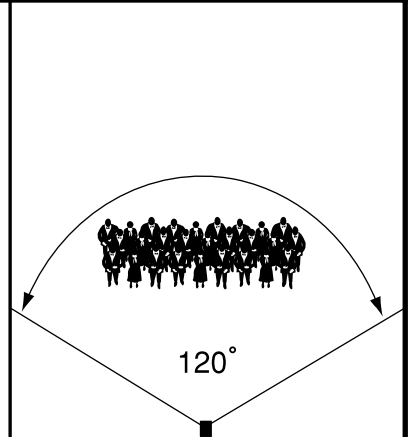

水平: 120°

縦置き2  
Group-Near

単位:mm

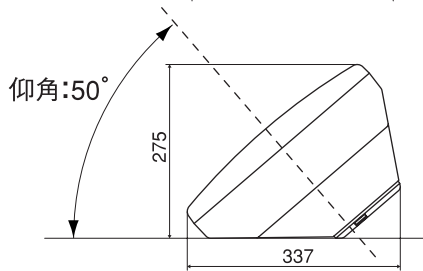
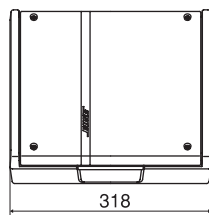

120°H ↓ 40°  
60°V

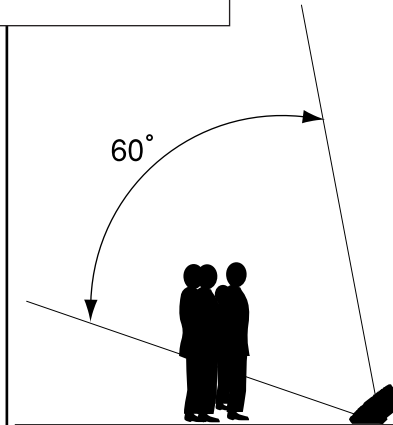

垂直: 60°

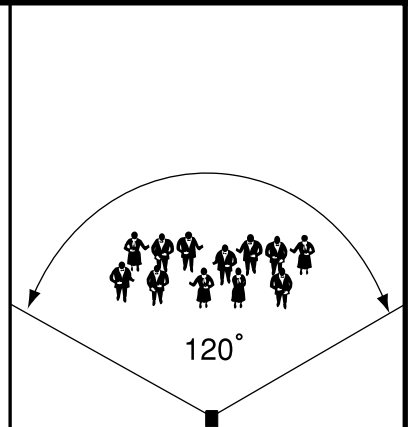

水平: 120°